



MNR MEDICAL COLLEGE & HOSPITAL

MNR Nagar, Fasalwadi, Sangareddy - 502 294, Sangareddy Dist. Telangana. India

Ph: + 85000 56667, (08455) 230523, 230527, 230524 Fax No. (08455) - 230555, 230533

CIRCULAR

Date: 07-10-2018

All the staff members and students are invited for a workshop titled "Ideathon" to be conducted by the ED Cell on 8th October 2018. The venue of the presentation is Demo Hall-II, Biochemistry. Please take this opportunity to enlighten yourself and enhance your career.

Principal

PRINCIPAL
MNR Medical College & Hospital
Fasalwadi, Sangareddy

Copy to

- Medical Superintendent
- CEO
- Assistant Director
- Chief Academic Officer
- IQAC
- Concerned HODs
- Notice Boards

Chairperson
Internal Quality Assurance Cell (IQAC)
MNR Medical College & Hospital



MNR MEDICAL COLLEGE & HOSPITAL

MNR Nagar, Fasalwadi, Sangareddy - 502 294, Sangareddy Dist. Telangana. India

Ph: + 85000 56667, (08455) 230523, 230527, 230524 Fax No. (08455) - 230555, 230533

Date: 09/10/2018

PROGRAM REPORT

Program Name: Workshop on "Ideathon"

Date of activity: 08/10/2018

Venue: Demo Hall-II, Biochemistry

Organized by: ED Cell

Resource person: Dr Venkatramanaiah Principal & Professor, Department of Forensic
Medicine, MNR Medical College & Hospital.

Number of participants: 96 Students & 13 Faculty

Objective of the program

The main objective of the goal of the Ideathon is to provide a platform for individuals to present their innovative ideas in a startup-like setting and receive feedback, mentorship, and potential investment opportunities.

Contents:

The Ideathon aims to foster creativity, collaboration, and problem-solving skills among our talented students. It is a platform where individuals or teams can present their groundbreaking ideas in various domains, such as technology, education, sustainability, social impact, Food technology, healthcare, and more.

Outcome of the program

This Ideathon will provide students a forum to showcase their abilities in conceptualizing ideas as well as the development of strategies for drug development, including novel chemical entities. Also, this interaction will provide students an opportunity to come face-to-face with experts from Industry in the area of drug development and delivery systems.

Chairperson
Internal Quality Assurance Cell (IQAC)
MNR Medical College & Hospital

PRINCIPAL
MNR Medical College & Hospital
Fasalwadi, Sanga Reddy



MNR MEDICAL COLLEGE & HOSPITAL

MNR Nagar, Fasalwadi, Sangareddy - 502 294, Sangareddy Dist. Telangana. India

Ph: + 85000 56667, (08455) 230523, 230527, 230524 Fax No. (08455) - 230555, 230533



MNR MEDICAL COLLEGE
FASALWADI, SANGAREDDY-502294

Chairperson,
Internal Quality Assurance Cell (IQAC)
MNR Medical College & Hospital

Chairperson
MEDICAL EDUCATION
MNR Medical College & Hospital



MNR MEDICAL COLLEGE & HOSPITAL

MNR Nagar, Fasalwadi, Sangareddy - 502 294, Sangareddy Dist. Telangana. India

Ph: + 85000 56667, (08455) 230523, 230527, 230524 Fax No. (08455) - 230555, 230533

Program Name: Workshop on "Ideathon"

Date of activity: 08/10/2018

S.No	Name of the participant	Course	Signature
1	KURELLI PAVAN KALYAN	MBBS	Pavan
2	PATLOLLA BHOOPAL REDDY	MBBS	Bhoopal Reddy
3	MEDI ANUP RAO	MBBS	ANUP
4	NUKALA NIHITHA	MBBS	NIHITHA
5	YASHASREE PASUPULETI	MBBS	yashasree
6	SOMA NITISH REDDY	MBBS	NITISH
7	ROSHAN KUMAR M	MBBS	Roshan
8	BANDYALA SAIKUMAR	MBBS	Saikumar
9	NIKHITA NADIMPALLI	MBBS	Nikhita
10	MUSKU NANDINI	MBBS	Musku
11	AKULA PALLAVI	MBBS	Pallavi
12	KONGALA RISHITHA	MBBS	Rishitha
13	GOLKONDA KARTHIK	MBBS	Karthik
14	BIRADAR SAIKUMAR	MBBS	Saikumar
15	NAIKOTI RAHUL	MBBS	Rahul
16	KOTHURU SUSHANTH	MBBS	Sushanth
17	SEVELLA MANOJ KUMAR	MBBS	Manoj
18	DANDYAR SHIVA PRASAD	MBBS	Shiva
19	BURRA JEEVANA	MBBS	Jeevana
20	MALELA BHANU PRASAD GOUD	MBBS	Bhanu
21	AKKENAPALLY RAJASHEKARACHARY	MBBS	Raja
22	JANGITI MANEESHA	MBBS	Maneesha
23	BOLLOJU GURU PRASAD	MBBS	Prasad
24	P SRILEKHA	MBBS	Srilekha

PRINCIPAL
MNR Medical College & Hospital
Fasalwadi, Sanga Reddy

Chairperson
Internal Quality Assurance Cell (IQAC)
MNR Medical College & Hospital



MNR MEDICAL COLLEGE & HOSPITAL

MNR Nagar, Fasalwadi, Sangareddy - 502 294, Sangareddy Dist. Telangana. India

Ph: + 85000 56667, (08455) 230523, 230527, 230524 Fax No. (08455) - 230555, 230533

25	MORAM STOTRA PRIYA	MBBS	Moram
26	RACHANA RAPOLU	MBBS	Rapalu
27	M MANISHA GOUD	MBBS	MANISHA
28	OGGU SRIKANTH	MBBS	Srikant
29	EDIGA SAI CHANDANA	MBBS	Chandana
30	MARUGONDA SAKETH VARMA	MBBS	Saketh
31	ANUMALLA MANASWINI	MBBS	Manas
32	BANDI NAVEEN KUMAR	MBBS	Naveen
33	SHAIK HASNAD BABA	MBBS	Hasnada
34	MAHEEN SULTANA	MBBS	Sultana
35	BANOTH VASANTH KUMAR	MBBS	Vasanth
36	B ANJALI NAIK	MBBS	Anjali Naik
37	MALAGARI MANEESHA	MBBS	Maneesha
38	CHINMAYEE DESAI	MBBS	Chinmayee
39	GAJULA SRI HARSHA CHAKRAVARTHY	MBBS	Harsha
40	MALKA HARSHITHA	MBBS	Harshitha
41	MENDI DEEKSHITHA	MBBS	Deekshitha
42	YATHAM SRI HARIKA	MBBS	Harika
43	J AISHWARYA	MBBS	Aishwarya
44	MUTHERAGALLA PRATHYUSHA	MBBS	Prathyusha
45	SEELAM LAXMI PRIYA	MBBS	Priya
46	BANDILA V V S TANMAIYEE	MBBS	Tanmaiye
47	GADDAM SRINIVAS	MBBS	Srinivas
48	SK AJEETH MUSHRAF	MBBS	Ajeeth
49	GAJULA CHANDRA HASA	MBBS	Chandrahasa
50	SALADI SAI VENKATA SOWMYA SARADA	MBBS	Sowmya
51	SHRUTI BOSE	MBBS	Shruti
52	DODDIPALLI BHANU PRAKASH REDDY	MBBS	Prakash
53	SABHADU SUSHMITHA	MBBS	Sushmitha
54	PRIYANKA RAJ KUMAWAT	MBBS	Priyanka

PRINCIPAL
MNR Medical College & Hospital
Fasalwadi, Sangareddy

Chairperson
Internal Quality Assurance Cell (IQAC)
MNR Medical College & Hospital





MNR MEDICAL COLLEGE & HOSPITAL

MNR Nagar, Fasalwadi, Sangareddy - 502 294, Sangareddy Dist. Telangana. India

Ph: + 85000 56667, (08455) 230523, 230527, 230524 Fax No. (08455) - 230555, 230533

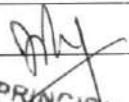
55	MUGA RITHIKA	MBBS	Rithika
56	R PRANITH KAMLAY	MBBS	R Kamlay
57	MARPALIKAR YOGESHWARI CHANDRAKANT	MBBS	MY Chandrakant
58	RAJA RAJESWAR REDDY ATTLA	MBBS	R Rajeswar
59	NABAMITA CHAKRABORTY	MBBS	N Chakraborty
60	SHUBAM DILIP SHINDE	MBBS	Shubam
61	BODDAM CHANDRALEKHA	MBBS	B Chandralekha
62	ROHIT JAJU	MBBS	Rohit
63	NABA KHANAM	MBBS	Nabakhanam
64	JAKAREGARI SOLOMON SUMAHITH SURATHAN	M.B.B.S	J Surathan
65	AMBATI SAI KEERTHANA	MBBS	Keerthana
66	DAKSHA LONAVATH	MBBS	D Lonavath
67	ESLAVATH GANESH KUMAR	MBBS	Ganesh
68	PANDHIPATI RAMYAPRIYA	MBBS	P Ramyapriya
69	GOLAMARI PRANAY PAUL REDDY	MBBS	Pranay
70	CHETANA MAHARANA	MBBS	C Maharana
71	RANOO PRIYAMBADA BISWAL	MBBS	A Biswal
72	KUKUDALA KEERTHI	MBBS	Keerthy
73	HAJIRA NOOREIN	MBBS	Noor
74	GRUSHA VARMA	MBBS	Varma
75	DURGAPPAGARI KIRANGOUD	M.B.B.S	D Kirangoud
76	DANUGURI UMA	MBBS	Uma
77	APPADI DIVYA	MBBS	Divya
78	GIDDY RAM VARSHITH REDDY	MBBS	V Reddy
79	KOTHAPALLI SAICHANDANA	MBBS	Saichandana
80	POLE MOUNIKA	MBBS	Mounika
81	ADELLI SRIDHAR	MBBS	Sri
82	BHUKYA HARSHA	MBBS	Harsh
83	PERUMANDLA HANISHA	MBBS	Hanisha
84	GEENUKUNTA AMRUTH KUMAR	MBBS	Amruth
85	JOGINAPALLY GAYATHRI	MBBS	Gayathri
86	GUNTOJU SUDEEP	MBBS	Sudeep

PRINCIPAL
MNR Medical College & Hospital
Fasalwadi, Sangareddy

Chairperson
Internal Quality Assurance Cell (IQAC)
MNR Medical College & Hospital



MNR MEDICAL COLLEGE & HOSPITAL

MNR Nagar, Fasalwadi, Sangareddy - 502 294, Sangareddy Dist. Telangana. India

Ph: + 85000 56667, (08455) 230523, 230527, 230524 Fax No. (08455) - 230555, 230533

87	NUTALAPATI MOHAN KRISHNA	MBBS.	Mohan
88	PRANEESHA REDDY KANDI	MBBS	Praneesha
89	RAPAKA SHERLY	MBBS	Sherly
90	SHIVDUTT S KANDI	MBBS	Shivdutt
91	KADIYALA LIKHITHAA	MBBS	Likhitha
92	YEDIVALLY PRASHANTH REDDY	MBBS	Prashanth
93	NITIN SHARMA	MBBS	Nitin
94	SAGGIDI NIKITHA	MBBS	Nikitha
95	PR RAJA RAMA CHANDRA REDDY	MBBS	Raja
96	ONTEDDU SHIRISHA	MBBS	Shirisha

Program Co-Ordinator
HOD

Chairperson
Internal Quality Assurance Cell (IQAC)
MNR Medical College & Hospital

FACULTY ATTENDANCE SHEET

Program Name: Workshop on "Ideathon"

Date of activity: 08/10/2018

S.No	Name of the Faculty	Department	Signature
1	Dr. Ilaiyah Yadav	General Surgery	Ilaiyah
2	Dr. Lingaraj Latuse	General medicine	Lingaraj
3	Dr. Sreenivas	General Surgery	Sreenivas
4	Dr. Keerthi Sreefud	Gen med	Keerthi

PRINCIPAL
MNR Medical College & Hospital
Fasalwadi, Sangareddy



MNR MEDICAL COLLEGE & HOSPITAL

MNR Nagar, Fasalwadi, Sangareddy - 502 294, Sangareddy Dist. Telangana. India

Ph: + 85000 56667, (08455) 230523, 230527, 230524 Fax No. (08455) - 230555, 230533

5	Dr. Sindhu Ayyagari	General Surgery	Sindhu
6	Dr. Bhavani	OBGYN	Bhavani
7	Dr. Babu Rao	Ophthalmology	Babu Rao
8	Dr. Sunitha	Anatomy	Sunitha
9	Dr. Sreenivas	General Surge	Sreenivas
10	Dr. P. Suresh	Microbiology	P. Suresh
11	Dr. Nagababu	Physician	Nagababu
12	Dr. Anvesha Prasad	General Surgery	Anvesha
13	Dr. Prasanna Kumari	OBGYN	Prasanna Kumari

Program Co-Ordinator
HOD

Chairperson
Internal Quality Assurance Cell (IQAC)
MNR Medical College & Hospital

PRINCIPAL
MNR Medical College & Hospital
Fasalwadi, Sangareddy



MNR Medical College

Fasalwadi, Sangareddy, Hyderabad, Telangana-502 294.

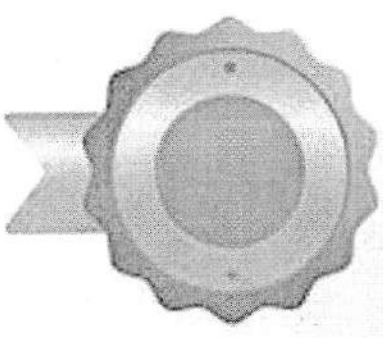

Certificate of Participation

This is to certify that

Mosam Sataa Piyu.

has participated in A Workshop on

Workshop on "Ideathon"

on 08/10/2018 organised by ED Cell, conducted at MNR Medical College,
Fasalwadi, Sangareddy, Hyderabad, Telangana-502 294.

Chairperson

Integral Quality Assurance Cell (IQAC)
MNR Medical College & Hospitals

Principal

MNR Medical College & Hospitals
Fasalwadi, Sangareddy-502294



MNR Medical College

Fasalwadi, Sangareddy, Hyderabad, Telangana-502 294.

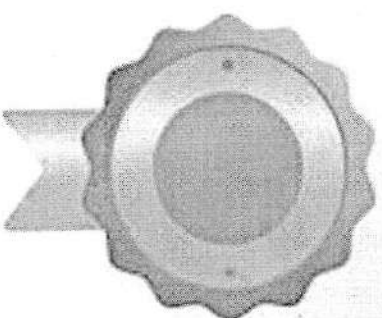

Certificate of Participation

This is to certify that

Bondi Naveen Kumar.

has participated in A Workshop on

Workshop on “Ideathon”

on 08/10/2018 organised by ED Cell, conducted at MNR Medical College,
Fasalwadi, Sangareddy, Hyderabad, Telangana-502 294.

Chairperson

Interpol Quality Assurance Cell (IQAC)
Convenor
MNR Medical College & Hospitals

PRINCIPAL
MNR MEDICAL COLLEGE & HOSPITALS
FASALWADI, SANGAREDDY-502294



MNR Medical College

Fasalwadi, Sangareddy, Hyderabad, Telangana-502 294.

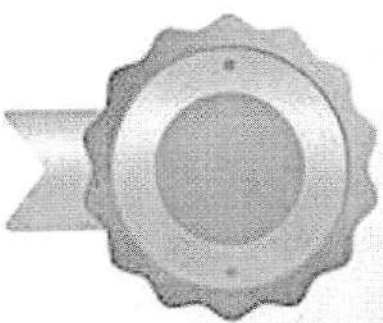

Certificate of Participation

This is to certify that

Ediga Sai chandra.

has participated in A Workshop on

Workshop on “Ideathon”

on 08/10/2018 organised by ED Cell, conducted at MNR Medical College,
Fasalwadi, Sangareddy, Hyderabad, Telangana-502 294.

Chairperson

Internal Quality Assurance Cell (IQAC),
CONVENOR
MNR Medical College & Hospitals

PRINCIPAL
MNR MEDICAL COLLEGE & HOSPITALS
FASALWADI, SANGAREDDY-502294



MNR Medical College

Fasalwadi, Sangareddy, Hyderabad, Telangana-502 294.

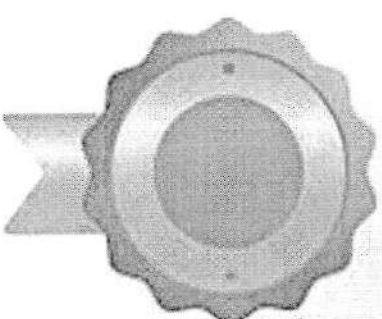

Certificate of Participation

This is to certify that

J. Ashwarya.

has participated in A Workshop on

Workshop on “Ideathon”

on 08/10/2018 organised by ED Cell, conducted at MNR Medical College,
Fasalwadi, Sangareddy, Hyderabad, Telangana-502 294.

Chairperson

Integral Quality Assurance Cell (IQAC),
Conyeneer
MNR Medical College & Hospitals

PRINCIPAL

MNR MEDICAL COLLEGE & HOSPITALS
Principal
FASALWADI, SANGAREDDY-502294



MNR Medical College

Fasalwadi, Sangareddy, Hyderabad, Telangana-502 294.

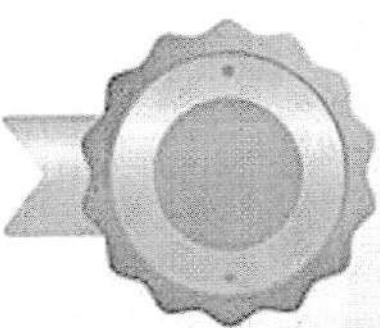

Certificate of Participation

This is to certify that

Dr. Chandrasakumar

has participated in A Workshop on

Workshop on “Ideathon”

on 08/10/2018 organised by ED Cell, conducted at MNR Medical College,
Fasalwadi, Sangareddy, Hyderabad, Telangana-502 294.

Chairperson

Internal Quality Assurance Cell (IQAC)
CONVENER
MNR Medical College & Hospitals

PRINCIPAL
MNR MEDICAL COLLEGE & HOSPITAL
FASALWADI, SANGAREDDY-502294



MNR Medical College

Fasalwadi, Sangareddy, Hyderabad, Telangana-502 294.

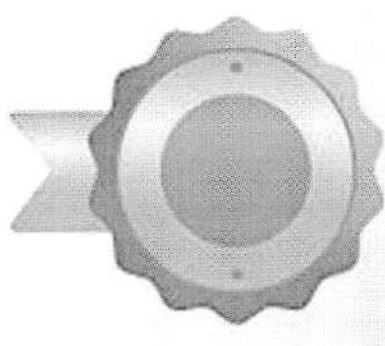

Certificate of Participation

This is to certify that

Dr. Fleishah Yarlow.

has participated in A Workshop on

Workshop on “Ideathon”

on 08/10/2018 organised by ED Cell, conducted at MNR Medical College,
Fasalwadi, Sangareddy, Hyderabad, Telangana-502 294.

Sandesh

Chairperson

Internal Quality Assurance Cell (IQAC)
MNR Medical College & Hospital

apb

PRINCIPAL

MNR MEDICAL COLLEGE & HOSPITAL
FASALWADI, SANGAREDDY-502294

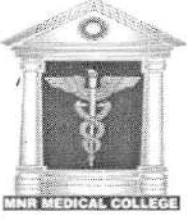

MNR MEDICAL COLLEGE & HOSPITAL

MNR Nagar, Fasalwadi, Sangareddy - 502 294, Sangareddy Dist. Telangana. India

Ph: + 85000 56667, (08455) 230523, 230527, 230524 Fax No. (08455) - 230555, 230533

CIRCULAR

Date: 16-12-2018

All the staff members and students are invited for a seminar titled "Demonstration of Injury on fruit" to be conducted by the R&D Cell on 17th December 2018. The venue of the presentation is Demo Hall-II, Biochemistry. Please take this opportunity to enlighten yourself and enhance your career.

Principal

PRINCIPAL
MNR Medical College & Hospital
Fasalwadi, Sangareddy

Copy to

- Medical Superintendent
- CEO
- Assistant Director
- Chief Academic Officer
- IQAC
- Concerned HODs
- Notice Boards

Chairperson
Internal Quality Assurance Cell (IQAC)
MNR Medical College & Hospital



MNR MEDICAL COLLEGE & HOSPITAL

MNR Nagar, Fasalwadi, Sangareddy - 502 294, Sangareddy Dist. Telangana. India

Ph: + 85000 56667, (08455) 230523, 230527, 230524 Fax No. (08455) - 230555, 230533

Date: 18/12/2018

PROGRAM REPORT

Program Name: "Demonstration of Injury on fruit"

Date of activity: 17/12/2018

Venue: Demo Hall-II, Biochemistry

Organized by: R&D Cell

Resource person: Dr Kiran Jumar J, Professor, Department of Forensic Medicine, St Paul's Hospital & Millennium Medical College, Ethiopia

Number of participants: 95 Students & 14 Faculty

Objective of the program

This study aims to highlight the potential serious complications of acute kidney injury (AKI) resulting from the consumption of excessive amounts of starfruit, a common traditional remedy.

Contents

- Chief complaints
- History of present illness
- Personal and Family history
- Physical examination
- Laboratory examinations

Outcome of the program

In Asian countries where star fruit is commonly consumed as a traditional remedy, it is imperative for emergency physicians to be aware of starfruit toxicity in patients with unexplained AKI. This will help identify and treat these patients promptly to prevent starfruit-induced nephrotoxicity. Patient history is the key to reaching an early diagnosis. It is essential to prevent starfruit nephrotoxicity by educating the public and especially diabetics on the risks of consuming excess starfruit.

Chairperson
Internal Quality Assurance Cell (IQAC)
MNR Medical College & Hospital



PRINCIPAL
MNR Medical College & Hospital
Fasalwadi, Sanga Reddy



MNR MEDICAL COLLEGE & HOSPITAL

MNR Nagar, Fasalwadi, Sangareddy – 502 294, Sangareddy Dist. Telangana. India

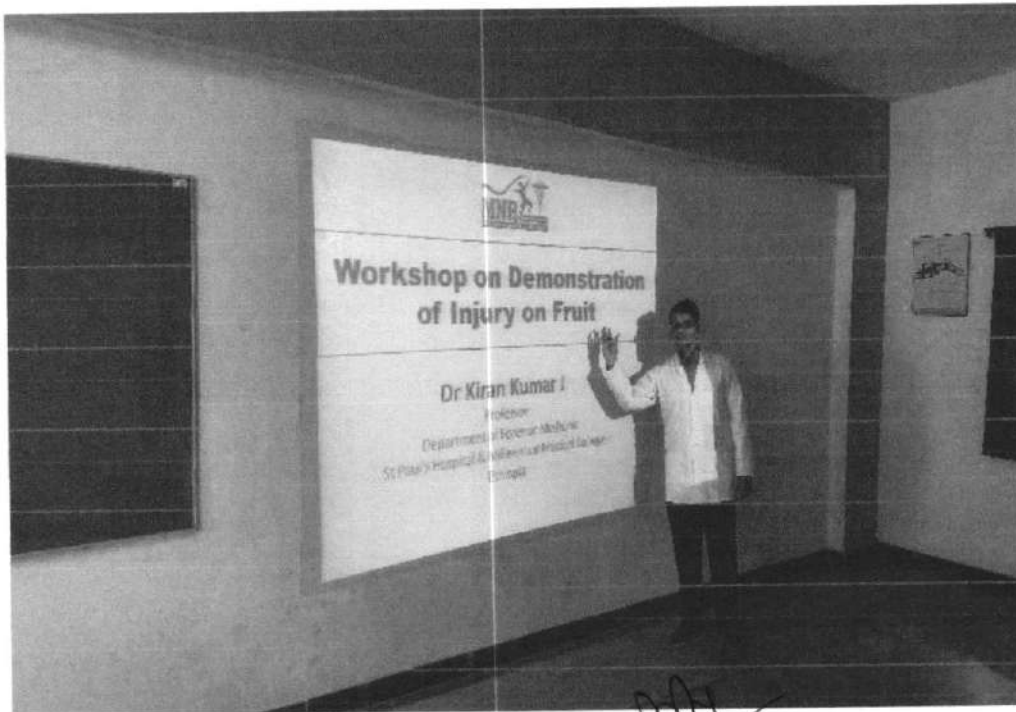
Ph: + 85000 56667, (08455) 230523, 230527, 230524 Fax No. (08455) – 230555, 230533



Chandra
Chairperson
Internal Quality Assurance Cell
MNR Medical College & Hospital

M
PRINCIPAL
MNR MEDICAL COLLEGE & HOSPITAL
FASALWADI, SANGAREDDY-502294

Chairperson
MEDICAL EDUCATION UNIT
MNR Medical College & Hospital



MNR MEDICAL COLLEGE & HOSPITAL

MNR Nagar, Fasalwadi, Sangareddy - 502 294, Sangareddy Dist. Telangana. India

Ph: + 85000 56667, (08455) 230523, 230527, 230524 Fax No. (08455) - 230555, 230533

Program Name: "Demonstration of Injury on fruit"

Date of activity: 17/12/2018

S.No	Name of the participant	Course	Signature
1	BURRA JEEVANA	MBBS	Jeevana
2	MALELA BHANU PRASAD GOUD	MBBS	Bhanu
3	AKKENAPALLY RAJASHEKARACHARY	MBBS	Rajsh
4	JANGITI MANEESHA	MBBS	Maneesha
5	BOLLOJU GURU PRASAD	MBBS	Guruf
6	P SRILEKHA	MBBS	Srilekha
7	MORAM STOTRA PRIYA	MBBS	Priya
8	RACHANA RAPOLU	MBBS	Rapolu
9	M MANISHA GOUD	MBBS	Manisha
10	OGGU SRIKANTH	MBBS	Srikanth
11	EDIGA SAI CHANDANA	MBBS	Chandana
12	MARUGONDA SAKETH VARMA	MBBS	Saketh
13	ANUMALLA MANASWINI	MBBS	Manaswini
14	BANDI NAVEEN KUMAR	MBBS	Naveen
15	SHAIK HASNAD BABA	MBBS	Hasn
16	MAHEEN SULTANA	MBBS	Maheen
17	BANOTH VASANTH KUMAR	MBBS	Vasanta
18	B ANJALI NAIK	MBBS	Anjali
19	MALAGARI MANEESHA	MBBS	Maneesha
20	CHINMAYEE DESAI	MBBS	Chinmayee
21	GAJULA SRI HARSHA CHAKRAVARTHY	MBBS	Sriharsha
22	MALKA HARSHITHA	MBBS	Harshitha
23	MENDI DEEKSHITHA	MBBS	Deekshitha
24	YATHAM SRI HARIKA	MBBS	Yatham

PRINCIPAL
MNR Medical College & Hospital
Fasalwadi, Sanga Reddy

Chairperson
Internal Quality Assurance Cell (IQAC)
MNR Medical College & Hospital



MNR MEDICAL COLLEGE & HOSPITAL

MNR Nagar, Fasalwadi, Sangareddy - 502 294, Sangareddy Dist. Telangana. India

Ph: + 85000 56667, (08455) 230523, 230527, 230524 Fax No. (08455) - 230555, 230533

25	J AISHWARYA	MBBS	Aishwarya
26	MUTHERAGALLA PRATHYUSHA	MBBS	Prathyusha
27	SEELAM LAXMI PRIYA	MBBS	Laxmi
28	BANDILA V V S TANMAIYEE	MBBS	Tanmai
29	GADDAM SRINIVAS	MBBS	Srinivas
30	SK AJEETH MUSHRAF	MBBS	Mushraf
31	GAJULA CHANDRA HASA	MBBS	Chandra
32	SALADI SAI VENKATA SOWMYA SARADA	MBBS	Sarada
33	SHRUTI BOSE	MBBS	Shruti
34	DODDIPALLI BHANU PRAKASH REDDY	MBBS	Bhanu
35	SABHADU SUSHMITHA	MBBS	Sushmita
36	PRIYANKA RAJ KUMAWAT	MBBS	Priyanka
37	MUGA RITHIKA	MBBS	Rithika
38	R PRANITH KAMLAY	MBBS	Pranith
39	MARPALIKAR YOGESHWARI CHANDRAKANT	MBBS	Yogeshwari
40	RAJA RAJESWAR REDDY ATTLA	MBBS	Raja
41	NABAMITA CHAKRABORTY	MBBS	Nabamita
42	SHUBAM DILIP SHINDE	MBBS	Shinde
43	BODDAM CHANDRALEKHA	MBBS	Chandralekh
44	ROHIT JAJU	MBBS	Rohit
45	NABA KHANAM	MBBS	Naba
46	JAKAREGARI SOLOMON SUMAHITH SURATHAN	MBBS	Solahith
47	AMBATI SAI KEERTHANA	MBBS	Sai
48	DAKSHA LONAVATH	MBBS	Daksh
49	ESLAVATH GANESH KUMAR	MBBS	Ganesh
50	PANDHIPATI RAMYAPRIYA	MBBS	Ramyapriya
51	GOLAMARI PRANAY PAUL REDDY	MBBS	Pranay
52	CHETANA MAHARANA	MBBS	Chetana
53	RANOO PRIYAMBADA BISWAL	MBBS	Priyambada
54	KUKUDALA KEERTHI	MBBS	Keerthi

PRINCIPAL
MNR Medical College & Hospital
Fasalwadi, Sangareddy

Internal Quality Assurance
MNR Medical College & Hospital



MNR MEDICAL COLLEGE & HOSPITAL

MNR Nagar, Fasalwadi, Sangareddy - 502 294, Sangareddy Dist. Telangana. India

Ph: + 85000 56667, (08455) 230523, 230527, 230524 Fax No. (08455) - 230555, 230533

55	HAJIRA NOOREIN	MBBS	Hajira
56	GRUSHA VARMA	MBBS	Grusha
57	DURGAPPAGARI KIRANGOUD	MBBS	Durgagoud
58	DANUGURI UMA	MBBS	Uma
59	APPADI DIVYA	MBBS	Divya
60	GIDDY RAM VARSHITH REDDY	MBBS	Varshith
61	KOTHAPALLI SAICHANDANA	MBBS	Chandana
62	POLE MOUNIKA	MBBS	Mounika
63	ADELLI SRIDHAR	MBBS	Adelli
64	BHUKYA HARSHA	MBBS	Harsha
65	PERUMANDLA HANISHA	MBBS	Hanisha
66	GEENUKUNTA AMRUTH KUMAR	MBBS	Amruth
67	JOGINAPALLY GAYATHRI	MBBS	Gayathri
68	GUNTOJU SUDEEP	MBBS	Sudeep
69	NUTALAPATI MOHAN KRISHNA	MBBS	Mohan
70	PRANEESHA REDDY KANDI	MBBS	Praneesha
71	RAPAKA SHERLY	MBBS	Sherly
72	SHIVDUTT S KANDI	MBBS	Shivdutt
73	KADIYALA LIKHITHAA	MBBS	Likhitha
74	YEDIVALLY PRASHANTH REDDY	MBBS	Prashanth
75	NITIN SHARMA	MBBS	Nitin
76	SAGGIDI NIKITHA	MBBS	Nikitha
77	PR RAJA RAMA CHANDRA REDDY	MBBS	Chandra
78	ONTEDDU SHIRISHA	MBBS	Shirisha
79	GUMMI LOKSAINATH REDDY	MBBS	Loksainath
80	SHAIK MD FAYAZ SHAHRUKH	MBBS	Fayaz
81	KUMILI SAI NIKHIL	MBBS	Sai
82	Dr. EMMADI UDAY	MBBS	Uday
83	Dr. KETHAVATH HARITHA	MBBS	Haritha
84	Dr. KONDEPUDI PALLAVI	MBBS	Pallavi
85	Dr. KOPPULA AKASH	MBBS	Akash
86	Dr. P SABITHA	MBBS	Sabitha
87	Dr. PAMIDI JHANAVI	MBBS	Jhanavi

PRINCIPAL
MNR Medical College & Hospital
Fasalwadi, Sanga Reddy

Chairperson
Internal Quality Assurance Cell
MNR Medical College & Hospital



MNR MEDICAL COLLEGE & HOSPITAL

MNR Nagar, Fasalwadi, Sangareddy - 502 294, Sangareddy Dist. Telangana. India

Ph: + 85000 56667, (08455) 230523, 230527, 230524 Fax No. (08455) - 230555, 230533

88	Dr. P PADMAVATHI	MBBS	Bhavanthi
89	Dr. LAVANYA KOROLLA	MBBS	Lavanya
90	Dr. S ASHOK	MBBS	Ashok
91	Dr. VELLAPAREDDY VISHNU PRIYA	MBBS	Vishnu
92	Dr. BENHER BEN RAJ KOMMU	MBBS	Kommu
93	Dr. LAVANYA PODILAPU	MBBS	Podilapu
94	Dr. B N SANDEEP KUMAR	MBBS	Kumar
95	Dr. BHAVANI ALDI	MBBS	Bhavanthi

Program Co-Ordinator
HOD

Chairperson
Internal Quality Assurance Cell (IQAC)
MNR Medical College & Hospital

FACULTY ATTENDANCE SHEET

Program Name: "Demonstration of Injury on fruit"

Date of activity: 17/12/2018

S.No	Name of the Faculty	Department	Signature
1	Dr. Vipul Chauhan	Medicine	Vipul Chauhan
2	Dr. Rudra Prasad	Gen Surg	Rudra Prasad
3	Dr. Babu Rana	OPHTHAL	Babu Rana
4	Dr. P. Anvesh	microbiology	P. Anvesh
5	Dr. Lingaraj Lalitha	Gen med	Lingaraj Lalitha

PRINCIPAL
MNR Medical College & Hospital
Fasalwadi, Sanga Reddy



MNR MEDICAL COLLEGE & HOSPITAL

MNR Nagar, Fasalwadi, Sangareddy - 502 294, Sangareddy Dist. Telangana. India

Ph: + 85000 56667, (08455) 230523, 230527, 230524 Fax No. (08455) - 230555, 230533

6	Dr. Keerthi Sree Reddy	General Medicine	
7	Dr. Soenirasa	General Surgeon	
8	Dr. Tharun Reddy	General Surgeon	
9	Dr. Bhavana	OBGYN	
10	Dr. Akshitha	SPM	
11	Dr. Anandha Prasad	General Surgeon	
12	Dr. Nagababu	Biochem	
13	Dr. Sunitha	Anatomy	
14	Dr. Prasanna Kelman	OBGYN	

Program Co-Ordinator
HOD

Chairperson
Internal Quality Assurance Cell (IQAC)
MNR Medical College & Hospital

PRINCIPAL
MNR Medical College & Hospital
Fasalwadi, Sangareddy



MNR Medical College

Fasalwadi, Sangareddy, Hyderabad, Telangana-502 294.

Certificate of Participation

This is to certify that

J. Ashwarya

has participated in A Seminar on

“Demonstration of Injury on fruit”

*on 17/12/2018 organised by P&D Cell, conducted at MNR Medical College,
Fasalwadi, Sangareddy, Hyderabad, Telangana-502 294.*

Chairperson

Internal Quality Assurance Cell (IQAC)
MNR Medical College & Hospital

Convener

Principal

MNR MEDICAL COLLEGE & HOSPITAL
FASALWADI, SANGAREDDY, 502294

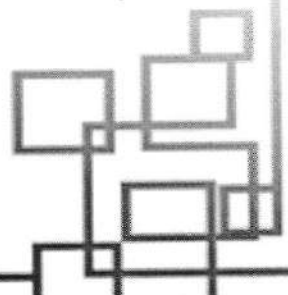



MNR Medical College

Fasalwadi, Sangareddy, Hyderabad, Telangana-502 294.

Certificate of Participation

This is to certify that

Gaddam Srinivas.

has participated in A Seminar on

“Demonstration of Injury on fruit”

*on 17/12/2018 organised by P&D Cells, conducted at MNR Medical College,
Fasalwadi, Sangareddy, Hyderabad, Telangana-502 294.*



Chairperson

Internal Quality Assurance Cell (IQAC)
MNR Medical College & Hospital

Convener



Principal

PRINCIPAL

MNR MEDICAL COLLEGE & HOSPITAL
FASALWADI, SANGAREDDY-502294

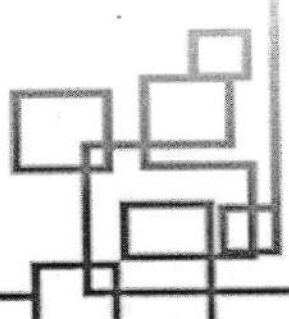



MNR Medical College

Fasalwadi, Sangareddy, Hyderabad, Telangana-502 294.

Certificate of Participation

This is to certify that

Muga Rithika.

has participated in A Seminar on

“Demonstration of Injury on fruit”

*on 17/12/2018 organised by P&D Cell, conducted at MNR Medical College,
Fasalwadi, Sangareddy, Hyderabad, Telangana-502 294.*

Chairperson

Convener

Principal

PRINCIPAL

MNR MEDICAL COLLEGE & HOSPITAL
FASALWADI, SANGAREDDY, 502294

Internal Quality Assurance Cell (IQAC)
MNR Medical College & Hospital

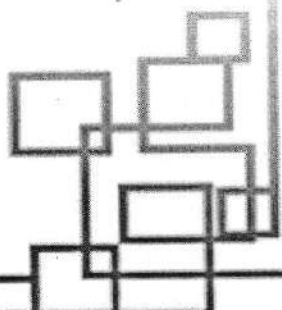



MNR Medical College

Fasalwadi, Sangareddy, Hyderabad, Telangana-502 294.

Certificate of Participation

This is to certify that

Dr. Harish Yadav.

has participated in A Seminar on

“Demonstration of Injury on fruit”

*on 17/12/2018 organised by P&D Cell, conducted at MNR Medical College,
Fasalwadi, Sangareddy, Hyderabad, Telangana-502 294.*

Chairperson

Internal Quality Assurance Cell (IQAC)
MNR Medical College & Hospital

Convener

Principal

MNR MEDICAL COLLEGE & HOSPITAL
FASALWADI, SANGAREDDY-502294



MNR Medical College

Fasalwadi, Sangareddy, Hyderabad, Telangana-502 294.

Certificate of Participation

This is to certify that

Dr. Rubra Prasad,

has participated in A Seminar on

“Demonstration of Injury on fruit”

*on 17/12/2018 organised by P&D Cell, conducted at MNR Medical College,
Fasalwadi, Sangareddy, Hyderabad, Telangana-502 294.*



Chairperson

Internal Quality Assurance Cell (IQAC)

MNR Medical College & Hospital

Convener



Principal

PRINCIPAL



MNR MEDICAL COLLEGE & HOSPITAL
FASALWADI, SANGAREDDY-502294

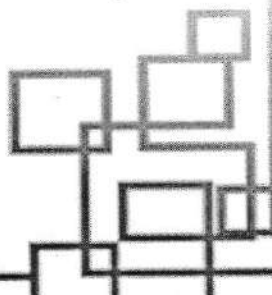



MNR Medical College

Fasalwadi, Sangareddy, Hyderabad, Telangana-502 294.

Certificate of Participation

This is to certify that

Dr. Babu Rao

has participated in A Seminar on

“Demonstration of Injury on fruit”

*on 17/12/2018 organised by P & D Bell, conducted at MNR Medical College,
Fasalwadi, Sangareddy, Hyderabad, Telangana-502 294.*



Chairperson

Internal Quality Assurance Cell (IQAC)
MNR Medical College & Hospital

Convener



Principal

PRINCIPAL

MNR MEDICAL COLLEGE & HOSPITAL
FASALWADI, SANGAREDDY, 502294

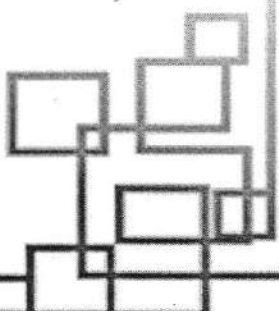



MNR MEDICAL COLLEGE & HOSPITAL

MNR Nagar, Fasalwadi, Sangareddy - 502 294, Sangareddy Dist. Telangana. India

Ph: + 85000 56667, (08455) 230523, 230527, 230524 Fax No. (08455) - 230555, 230533

CIRCULAR

Date: 19-06-2018

All the staff members and students are invited for a workshop titled "Workshop on writing a research paper" to be conducted by the R&D Cell on 20th June 2018. The venue of the presentation is Demo Hall-II, Biochemistry. Please take this opportunity to enlighten yourself and enhance your career.

Principal

Copy to

- Medical Superintendent
- CEO
- Assistant Director
- Chief Academic Officer
- IQAC
- Concerned HODs
- Notice Boards

PRINCIPAL
MNR Medical College & Hospital
Fasalwadi, Sangareddy

Chairperson
Internal Quality Assurance Cell (IQAC)
MNR Medical College & Hospital



MNR MEDICAL COLLEGE & HOSPITAL

MNR Nagar, Fasalwadi, Sangareddy - 502 294, Sangareddy Dist. Telangana. India

Ph: + 85000 56667, (08455) 230523, 230527, 230524 Fax No. (08455) - 230555, 230533

Date: 21/06/2018

PROGRAM REPORT

Program Name: "Workshop on writing a research paper"

Date of activity: 20/06/2018

Venue: Demo Hall-II, Biochemistry

Organized by: R&D Cell

Resource person: Dr Chandrakumar S, Professor, Lab Consultant, Department of Pathology,
RVM Institute of Medical Sciences and Research Center, Siddipet, Telangana

Number of participants: 94 Students & 13 Faculty

Objective of the program

The main objective of the program is to know about research methodology and its importance. One of the most important aspects of a thesis, dissertation or research paper is the correct formulation of the aims and objectives. This is because your aims and objectives will establish the scope, depth and direction that your research will ultimately take.

Contents Delivered

- Understand the assignment
- Choose a research paper topic
- Conduct preliminary research
- Create a research paper outline
- Paragraph structure
- Citing sources

Chairperson
Internal Qu...
MNR M-

Outcome of the program

All the participants were welcomed and the event started with good note in the presence of Principal MNR Medical College & Hospital. The Event covered the aspects of the importance of research and research paper writing in medical field. The event also covered the importance of the research, quality of research, research paper writing and publishing in reputed journal. The

PRINCIPAL

MNR Medical College & Hospital
Fasalwadi, Sangareddy



MNR MEDICAL COLLEGE & HOSPITAL

MNR Nagar, Fasalwadi, Sangareddy - 502 294, Sangareddy Dist. Telangana. India

Ph: + 85000 56667, (08455) 230523, 230527, 230524 Fax No. (08455) - 230555, 230533

overall methods to write paper, heading, domains to be considered while drafting paper and how to avoid plagiarism to enhance the uniqueness and quality of paper were discussed.

Chairperson
Internal Quality Assurance Cell (IQAC)
MNR Medical College & Hospital

PRINCIPAL
MNR Medical College & Hospital
Fasalwadi, Sanga Reddy



MNR MEDICAL COLLEGE & HOSPITAL

MNR Nagar, Fasalwadi, Sangareddy - 502 294, Sangareddy Dist. Telangana. India

Ph: + 85000 56667, (08455) 230523, 230527, 230524 Fax No. (08455) - 230555, 230533



Program Co-Ordinator

Chandrasekhar
Internal Quality Assurance Committee
MNR Medical College & Hospital

[Signature]
Principal

MNR MEDICAL COLLEGE & HOSPITAL
FASALWADI, SANGAREDDY-502294

HOD

Chairperson
MEDICAL EDUCATION UNIT
MNR Medical College & Hospital



MNR MEDICAL COLLEGE & HOSPITAL

MNR Nagar, Fasalwadi, Sangareddy - 502 294, Sangareddy Dist. Telangana. India

Ph: + 85000 56667, (08455) 230523, 230527, 230524 Fax No. (08455) - 230555, 230533

STUDENT ATTENDANCE SHEET

Program Name: "Workshop on writing a research paper"

Date of activity: 20/06/2018

S.No	Name of the participant	Course	Signature
1	MEDI ANUP RAO	MBBS	Anup
2	NUKALA NIHITHA	MBBS	Nikhita
3	YASHASREE PASUPULETI	MBBS	Yashasree
4	SOMA NITISH REDDY	MBBS	Nitish
5	ROSHAN KUMAR M	MBBS	Roshan
6	BANDYALA SAIKUMAR	MBBS	Saikumar
7	NIKHITA NADIMPALLI	MBBS	Nikhita
8	MUSKU NANDINI	MBBS	M. Nandini
9	AKULA PALLAVI	MBBS	Pallavi
10	KONGALA RISHITHA	MBBS	Rishitha
11	GOLKONDA KARTHIK	MBBS	Karthik
12	BIRADAR SAIKUMAR	MBBS	Saikumar
13	NAIKOTI RAHUL	MBBS	Rahul
14	KOTHURU SUSHANTH	MBBS	Sushanth
15	SEVELLA MANOJ KUMAR	MBBS	Manoj
16	DANDYAR SHIVA PRASAD	MBBS	Shiva
17	BURRA JEEVANA	MBBS	Jeevana
18	MALELA BHANU PRASAD GOUD	MBBS	Prasad
19	AKKENAPALLY RAJASHEKARACHARY	MBBS	Rajshekarachary
20	JANGITI MANEESHA	MBBS	Maneesha
21	BOLLOJU GURU PRASAD	MBBS	Guru

PRINCIPAL
MNR Medical College & Hospital
Fasalwadi, Sanga Reddy

Chairperson
Internal Quality Assurance Cell (IQAC)
MNR Medical College & Hospital



MNR MEDICAL COLLEGE & HOSPITAL

MNR Nagar, Fasalwadi, Sangareddy - 502 294, Sangareddy Dist. Telangana. India

Ph: + 85000 56667, (08455) 230523, 230527, 230524 Fax No. (08455) - 230555, 230533

22	P SRILEKHA	MBBS	<i>Srilekha</i>
23	MORAM STOTRA PRIYA	MBBS	<i>Priya</i>
24	RACHANA RAPOLU	MBBS	<i>Rachana</i>
25	M MANISHA GOUD	MBBS	<i>Manisha</i>
26	OGGU SRIKANTH	MBBS	<i>Srikanth</i>
27	EDIGA SAI CHANDANA	MBBS	<i>Chandana</i>
28	MARUGONDA SAKETH VARMA	MBBS	<i>Saketh</i>
29	ANUMALLA MANASWINI	MBBS	<i>Manaswini</i>
30	BANDI NAVEEN KUMAR	MBBS	<i>Naveen</i>
31	SHAIK HASNAD BABA	MBBS	<i>Hasnad</i>
32	MAHEEN SULTANA	MBBS	<i>Sultana</i>
33	BANOTH VASANTH KUMAR	MBBS	<i>Vasanth</i>
34	B ANJALI NAIK	MBBS	<i>Anjali</i>
35	MALAGARI MANEESHA	MBBS	<i>Maneesha</i>
36	CHINMAYEE DESAI	MBBS	<i>Chinmayee</i>
37	GAJULA SRI HARSHA CHAKRAVARTHY	MBBS	<i>Harsha</i>
38	MALKA HARSHITHA	MBBS	<i>Harshitha</i>
39	MENDI DEEKSHITHA	MBBS	<i>Deekshitha</i>
40	YATHAM SRI HARIKA	MBBS	<i>Harika</i>
41	J AISHWARYA	MBBS	<i>Aishwarya</i>
42	MUTHERAGALLA PRATHYUSHA	MBBS	<i>Prathyusha</i>
43	SEELAM LAXMI PRIYA	MBBS	<i>Laxmi</i>
44	BANDILA V V S TANMAIYEE	MBBS	<i>Tanmaiye</i>
45	GADDAM SRINIVAS	MBBS	<i>Srinivas</i>
46	SK AJEETH MUSHRAF	MBBS	<i>Ajeeth</i>
47	GAJULA CHANDRA HASA	MBBS	<i>Hasa</i>
48	SALADI SAI VENKATA SOWMYA SARADA	MBBS	<i>Sowmya</i>

PRINCIPAL

MNR Medical College & Hospital
Fasalwadi, Sangareddy

Chairperson

Internal Quality Assurance Cell (IQAC)
MNR Medical College & Hospital



MNR MEDICAL COLLEGE & HOSPITAL

MNR Nagar, Fasalwadi, Sangareddy - 502 294, Sangareddy Dist. Telangana. India

Ph: + 85000 56667, (08455) 230523, 230527, 230524 Fax No. (08455) - 230555, 230533

49	SHRUTI BOSE	MBBS	Shruti
50	DODDIPALLI BHANU PRAKASH REDDY	MBBS	Prakash
51	SABHADU SUSHMITHA	MBBS	Sushmitha
52	PRIYANKA RAJ KUMAWAT	MBBS	Priyanka
53	MUGA RITHIKA	MBBS	Rithika
54	R PRANITH KAMLAY	MBBS	Pranith.
55	MARPALIKAR YOGESHWARI CHANDRAKANT	MBBS	Yogeshwari
56	RAJA RAJESWAR REDDY ATTLA	MBBS	Rajeswar.
57	NABAMITA CHAKRABORTY	MBBS	Nabamita
58	SHUBAM DILIP SHINDE	MBBS	Dilip.
59	BODDAM CHANDRALEKHA	MBBS	Chandrala
60	ROHIT JAJU	MBBS	Rohit.
61	NABA KHANAM	MBBS	Khanam
62	JAKAREGARI SOLOMON SUMAHITH SURATHAN	MBBS	Sumahith
63	AMBATI SAI KEERTHANA	MBBS	Keertana.
64	DAKSHA LONAVATH	MBBS	Daksha
65	ESLAVATH GANESH KUMAR	MBBS	Ganesh
66	PANDHIPATI RAMYAPRIYA	MBBS	Ramyapriya
67	GOLAMARI PRANAY PAUL REDDY	MBBS	Pranay
68	CHETANA MAHARANA	MBBS	Chetana
69	RANOO PRIYAMBADA BISWAL	MBBS	Priyambada
70	KUKUDALA KEERTHI	MBBS	Keerthi
71	HAJIRA NOOREIN	MBBS	Hajira
72	GRUSHA VARMA	MBBS	Grusha
73	DURGAPPAGARI KIRANGOUD	MBBS	Kirangoud
74	DANUGURI UMA	MBBS	Uma.
75	APPADI DIVYA	MBBS	Divya.
76	GIDDY RAM VARSHITH REDDY	MBBS	Varshith.
77	KOTHAPALLI SAICHANDANA	MBBS	Saichandana
78	POLE MOUNIKA	MBBS	Mounika

PRINCIPAL
MNR Medical College & Hospital
Fasalwadi, Sanga Reddy

Internal Quality Assurance Cell (IQAC)
MNR Medical College & Hospital



MNR MEDICAL COLLEGE & HOSPITAL

MNR Nagar, Fasalwadi, Sangareddy - 502 294, Sangareddy Dist. Telangana. India

Ph: + 85000 56667, (08455) 230523, 230527, 230524 Fax No. (08455) - 230555, 230533

79	ADELLI SRIDHAR	MBBS	Sridhar
80	BHUKYA HARSHA	MBBS	Harsha
81	PERUMANDLA HANISHA	MBBS	Hanisha
82	GEENUKUNTA AMRUTH KUMAR	MBBS	Amruth
83	JOGINAPALLY GAYATHRI	MBBS	Gayatri
84	GUNTOJU SUDEEP	MBBS	Sudeep
85	NUTALAPATI MOHAN KRISHNA	MBBS	Mohan
86	PRANEESHA REDDY KANDI	MBBS	Praneesha
87	RAPAKA SHERLY	MBBS	Sherly
88	SHIVDUTT S KANDI	MBBS	Shivdutt
89	KADIYALA LIKHITHAA	MBBS	Likhitha
90	YEDIVALLY PRASHANTH REDDY	MBBS	Prashant
91	NITIN SHARMA	MBBS	Nitin
92	SAGGIDI NIKITHA	MBBS	Nikitha
93	PR RAJA RAMA CHANDRA REDDY	MBBS	Ram
94	ONTEDDU SHIRISHA	MBBS	Shirisha

Program Co-Ordinator

HOD

PRINCIPAL
MNR Medical College & Hospital
Fasalwadi, Sanga Reddy

Chairperson
Internal Quality Assurance Cell (IQAC)
MNR Medical College & Hospital



MNR MEDICAL COLLEGE & HOSPITAL

MNR Nagar, Fasalwadi, Sangareddy - 502 294, Sangareddy Dist. Telangana. India

Ph: + 85000 56667, (08455) 230523, 230527, 230524 Fax No. (08455) - 230555, 230533

FACULTY ATTENDANCE SHEET

Program Name: "Workshop on writing a research paper"

Date of activity: 20/06/2018

S.No	Name of the Faculty	Department	Signature
1	Dr. Bharani	OBGY	Bharani
2	Dr. N. Deepa	ophthal	Deepa
3	Dr. Sai Sivani	General medicine	Sai Sivani
4	Dr. Babu Rao	ophthal	Babu Rao
5	Dr. Sindhu	General surgery	Sindhu
6	Dr. Ilaiyah Yadau	General surgery	Ilaiyah Yadau
7	Dr. Nagababu	Biochemistry	Nagababu
8	Dr. Indira	General medicine	Indira
9	Dr. Anandha Prakash	General surgery	Anandha Prakash
10	Dr. Anurag Yadav	Biochem	Anurag Yadav
11	Dr. Chandrasekhar S.	Pathol.	Chandrasekhar S.
12	Dr. Sunitha	Anatomy	Sunitha
13	Dr. P. Suresh	microbiology	P. Suresh

Program Co-Ordinator
HOD

PRINCIPAL

MNR Medical College & Hospital
Fasalwadi, Sanga Reddy

Internal Quality Assurance Cell (IQAC)
MNR Medical College & Hospital



MNR Medical College

Fasalwadi, Sangareddy, Hyderabad, Telangana-502 294.

Certificate of Participation

This is to certify that

Dr. Suresh

has participated in A SWorkshop on

“Writing a Research Paper”

on 20/06/2018 organised by R&D Cell, conducted at MNR Medical College,
Fasalwadi, Sangareddy, Hyderabad, Telangana-502 294.

Chairperson
Internal Quality Assurance Cell (IQAC)
MNR Medical College & Hospital

Convener

Principal

PRINCIPAL
MNR MEDICAL COLLEGE & HOSPITAL
FASALWADI, SANGAREDDY-502294



MNR Medical College

Fasalwadi, Sangareddy, Hyderabad, Telangana-502 294.

Certificate of Participation

This is to certify that

Medi Anup Rao

has participated in A SWorkshop on

“Writing a Research Paper”

on 20/06/2018 organised by R&D Cell, conducted at MNR Medical College,
Fasalwadi, Sangareddy, Hyderabad, Telangana-502 294.

Chairperson
Internal Quality Assurance Cell (IQAC)
MNR Medical College & Hospital

Convener

Principal

PRINCIPAL
MNR MEDICAL COLLEGE & HOSPITAL
FASALWADI, SANGAREDDY-502294



MNR Medical College

Fasalwadi, Sangareddy, Hyderabad, Telangana-502 294.

Certificate of Participation

This is to certify that

Akula Pallavi

has participated in A SWorkshop on

“Writing a Research Paper”

on 20/06/2018 organised by R&D Cell, conducted at MNR Medical College,
Fasalwadi, Sangareddy, Hyderabad, Telangana-502 294.

Chairperson
Internal Quality Assurance Cell (IQAC)
MNR Medical College & Hospital

Convener

Principal

PRINCIPAL
MNR MEDICAL COLLEGE & HOSPITAL
FASALWADI, SANGAREDDY-502294



MNR Medical College

Fasalwadi, Sangareddy, Hyderabad, Telangana-502 294.

Certificate of Participation

This is to certify that

Maikoti Rahul

has participated in A SWorkshop on

“Writing a Research Paper”

on 20/06/2018 organised by R&D Cell, conducted at MNR Medical College,
Fasalwadi, Sangareddy, Hyderabad, Telangana-502 294.

Chairperson
Internal Quality Assurance Cell (IQAC)
MNR Medical College & Hospital

Convener

Principal

PRINCIPAL
MNR MEDICAL COLLEGE & HOSPITAL
FASALWADI, SANGAREDDY-502294



MNR Medical College

Fasalwadi, Sangareddy, Hyderabad, Telangana-502 294.

Certificate of Participation

This is to certify that

Dr. Nagababu

has participated in A SWorkshop on

“Writing a Research Paper”

on 20/06/2018 organised by R&D Cell, conducted at MNR Medical College,
Fasalwadi, Sangareddy, Hyderabad, Telangana-502 294.

Chairperson
Internal Quality Assurance Cell (IQAC)
MNR Medical College & Hospital

Convener

Principal

PRINCIPAL
MNR MEDICAL COLLEGE & HOSPITAL
FASALWADI, SANGAREDDY-502294



MNR Medical College

Fasalwadi, Sangareddy, Hyderabad, Telangana-502 294.

Certificate of Participation

This is to certify that

Dr. Deepika

has participated in A SWorkshop on

“Writing a Research Paper”

on 20/06/2018 organised by R&D Cell, conducted at MNR Medical College,
Fasalwadi, Sangareddy, Hyderabad, Telangana-502 294.

Chairperson
Internal Quality Assurance Cell (IQAC)
MNR Medical College & Hospital

Convener

Principal

PRINCIPAL
MNR MEDICAL COLLEGE & HOSPITAL
FASALWADI, SANGAREDDY-502294



MNR MEDICAL COLLEGE & HOSPITAL

MNR Nagar, Fasalwadi, Sangareddy - 502 294, Sangareddy Dist. Telangana. India

Ph: + 85000 56667, (08455) 230523, 230527, 230524 Fax No. (08455) - 230555, 230533

CIRCULAR

Date: 16-07-2018

All the staff members and students are invited for a workshop titled "Workshop on Biostatistics" to be conducted by the R&D Cell on 17th July 2018. The venue of the presentation is Biochemistry Demo Hall 2. Please take this opportunity to enlighten yourself and enhance your career.

Principal

Copy to

- Medical Superintendent
- CEO
- Assistant Director
- Chief Academic Officer
- IQAC
- Concerned HODs
- Notice Boards

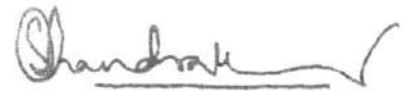

Chairperson
Internal Quality Assurance Cell (IQAC)
MNR Medical College & Hospital

PRINCIPAL
MNR Medical College & Hospital,
Fasalwadi, Sanga Reddy.

Date: 18/07/2018

PROGRAM REPORT



MNR MEDICAL COLLEGE & HOSPITAL

MNR Nagar, Fasalwadi, Sangareddy - 502 294, Sangareddy Dist. Telangana. India

Ph: + 85000 56667, (08455) 230523, 230527, 230524 Fax No. (08455) - 230555, 230533

Program Name: "Workshop on Biostatistics"

Date of activity: 17/07/2018

Venue: Biochemistry Demo Hall 2

Organized by: R&D Cell

Resource person: Mr Simhadri M Tutor and Research Data scientist, Community Medicine Department, MNR Medical College & Hospital, Sangareddy

Number of participants: 93 Students & 11 Faculty

Objective of the program

Seminar was organized for the Students and Academicians to The objective of Biostatistics is to advance statistical science and its application to problems of human health and disease, with the ultimate goal of advancing the public's health.

Contents Delivered

- Case Studies.
- Correlational Studies.
- Longitudinal Studies.
- Experimental Studies.
- Clinical Trial Studies.

Outcome of the program

The participants of the Seminar will be able to understand the discipline of biostatistics which provides tools and techniques for collecting data and then summarizing, analyzing, and interpreting it. If the samples one takes are representative of the population of interest, they will provide good estimates regarding the population overall.

PRINCIPAL
MNR Medical College & Hospital
Fasalwadi, Sanga Reddy

Chairperson
Internal Quality Assurance Cell (IQAC)
MNR Medical College & Hospital



MNR MEDICAL COLLEGE & HOSPITAL

MNR Nagar, Fasalwadi, Sangareddy - 502 294, Sangareddy Dist. Telangana. India

Ph: + 85000 56667, (08455) 230523, 230527, 230524 Fax No. (08455) - 230555, 230533

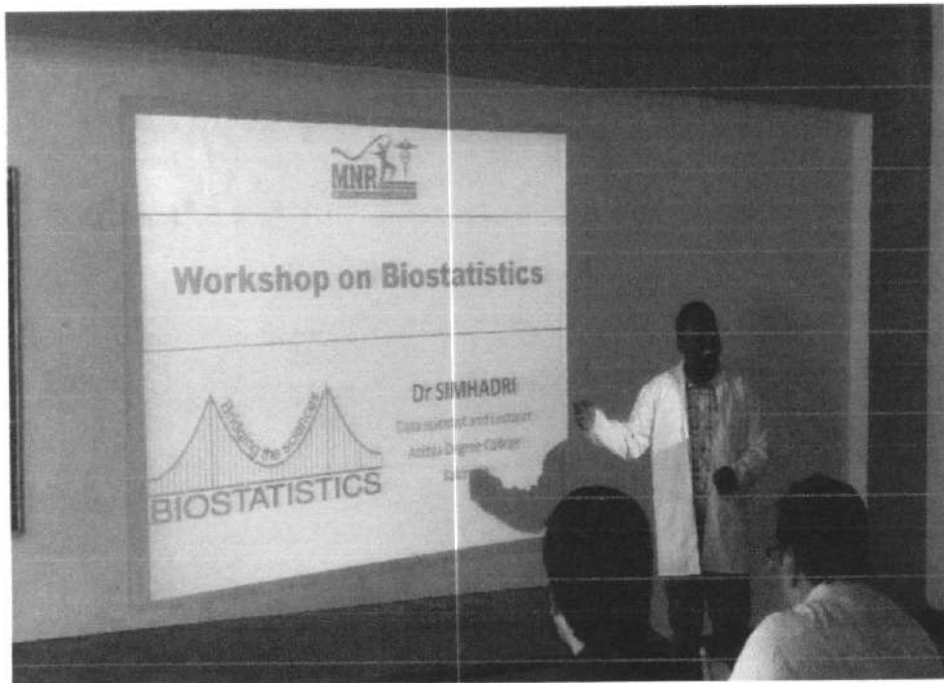
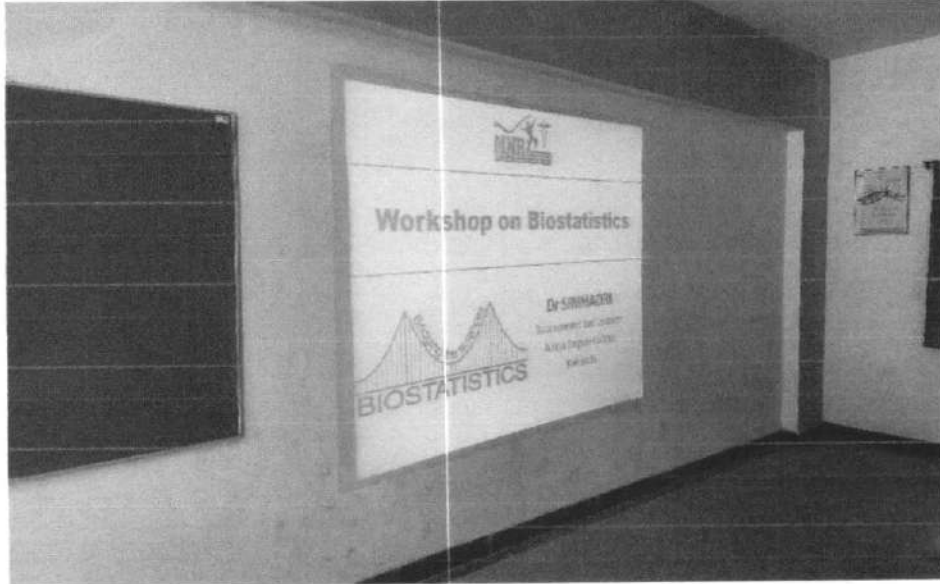

PRINCIPAL
MNR MEDICAL COLLEGE & HOSPITAL
FASALWADI, SANGAREDDY-502294

Internal Quality Assurance Cell (IQAC)
MNR Medical College & Hospital

ACCREDITATION UNIT
MNR Medical College & Hospital



MNR MEDICAL COLLEGE & HOSPITAL

MNR Nagar, Fasalwadi, Sangareddy - 502 294, Sangareddy Dist. Telangana. India

Ph: + 85000 56667, (08455) 230523, 230527, 230524 Fax No. (08455) - 230555, 230533

Date of activity: 17/07/2018

S.No	Name of the participant	Course	Signature
1	KURELLI PAVAN KALYAN	MBBS	Pavan Kalyan
2	PATLOLLA BHOOPAL REDDY	MBBS	Bhoopal Reddy
3	MEDI ANUP RAO	MBBS	Anup Rao
4	NUKALA NIHITHA	MBBS	Nihitha
5	YASHASREE PASUPULETI	MBBS	Yashasree
6	SOMA NITISH REDDY	MBBS	Nitish Reddy
7	ROSHAN KUMAR M	MBBS	Roshan Kumar
8	BANDYALA SAIKUMAR	MBBS	Saikumar
9	NIKHITA NADIMPALLI	MBBS	Nikhita
10	MUSKU NANDINI	MBBS	Nandini
11	AKULA PALLAVI	MBBS	Pallavi
12	KONGALA RISHITHA	MBBS	Rishitha
13	GOLKONDA KARTHIK	MBBS	Karthik
14	BIRADAR SAIKUMAR	MBBS	Saikumar
15	NAIKOTI RAHUL	MBBS	Rahul
16	KOTHURU SUSHANTH	MBBS	Sushanth
17	SEVELLA MANOJ KUMAR	MBBS	Manoj Kumar
18	DANDYAR SHIVA PRASAD	MBBS	Shiva Prasad
19	BURRA JEEVANA	MBBS	Jeevana
20	MALELA BHANU PRASAD GOUD	MBBS	Bhanu
21	AKKENAPALLY RAJASHEKARACHARY	MBBS	Rajashekarachary
22	JANGITI MANEESHA	MBBS	Maneesha
23	BOLLOJU GURU PRASAD	MBBS	Guru Prasad
24	P SRILEKHA	MBBS	Srilekha
25	MORAM STOTRA PRIYA	MBBS	Stotra Priya

PRINCIPAL
MNR Medical College & Hospital
Fasalwadi, Sanga Reddy

Chairperson
Internal Quality Assurance Cell (IQAC)
MNR Medical College & Hospital



MNR MEDICAL COLLEGE & HOSPITAL

MNR Nagar, Fasalwadi, Sangareddy - 502 294, Sangareddy Dist. Telangana. India

Ph: + 85000 56667, (08455) 230523, 230527, 230524 Fax No. (08455) - 230555, 230533

26	RACHANA RAPOLU	MBBS	Rachana
27	M MANISHA GOUD	MBBS	Manisha
28	OGGU SRIKANTH	MBBS	Ogguru
29	EDIGA SAI CHANDANA	MBBS	Ediga
30	MARUGONDA SAKETH VARMA	MBBS	Saketh
31	ANUMALLA MANASWINI	MBBS	Manaswini
32	BANDI NAVEEN KUMAR	MBBS	Naveen
33	SHAIK HASNAD BABA	MBBS	Shaik
34	MAHEEN SULTANA	MBBS	Maheen
35	BANOTH VASANTH KUMAR	MBBS	Varshath
36	B ANJALI NAIK	MBBS	Anjali
37	MALAGARI MANEESHA	MBBS	Maneesh
38	CHINMAYEE DESAI	MBBS	Desai
39	GAJULA SRI HARSHA CHAKRAVARTHY	MBBS	Harsha
40	MALKA HARSHITHA	MBBS	Malika
41	MENDI DEEKSHITHA	MBBS	Deekshitha
42	YATHAM SRI HARIKA	MBBS	Harika
43	J AISHWARYA	MBBS	Aishwarya
44	MUTHERAGALLA PRATHYUSHA	MBBS	Prathyusha
45	SEELAM LAXMI PRIYA	MBBS	Laxmi
46	BANDILA V V S TANMAIYEE	MBBS	Tanmaiyye
47	GADDAM SRINIVAS	MBBS	Srinivas
48	SK AJEETH MUSHRAF	MBBS	Ajeeth
49	GAJULA CHANDRA HASA	MBBS	Hasa
50	SALADI SAI VENKATA SOWMYA SARADA	MBBS	Sowmya
51	SHRUTI BOSE	MBBS	Shruti
52	DODDIPALLI BHANU PRAKASH REDDY	MBBS	Bhanu
53	SABHADU SUSHMITHA	MBBS	Sushmitha
54	PRIYANKA RAJ KUMAWAT	MBBS	Priyanka
55	MUGA RITHIKA	MBBS	Rithika

PRINCIPAL
MNR Medical College & Hospital
Fasalwadi, Sanga Reddy

Chairperson
Internal Quality Assurance Cell (IQAC)
MNR Medical College & Hospital



MNR MEDICAL COLLEGE & HOSPITAL

MNR Nagar, Fasalwadi, Sangareddy - 502 294, Sangareddy Dist. Telangana. India

Ph: + 85000 56667, (08455) 230523, 230527, 230524 Fax No. (08455) - 230555, 230533

56	R PRANITH KAMLAY	MBBS	Pranith
57	MARPALIKAR YOGESHWARI CHANDRAKANT	MBBS.	Chandrakant
58	RAJA RAJESWAR REDDY ATTLA	MBBS	Rajul.
59	NABAMITA CHAKRABORTY	MBBS	Nabamita
60	SHUBAM DILIP SHINDE	MBBS	Shubam
61	BODDAM CHANDRALEKHA	MBBS	Chandru
62	ROHIT JAJU	MBBS	Rohit
63	NABA KHANAM	MBBS	Nabamita
64	JAKAREGARI SOLOMON SUMAHITH SURATHAN	MBBS	Sumithra
65	AMBATI SAI KEERTHANA	MBBS	Keerthana
66	DAKSHA LONAVATH	MBBS.	Daksha
67	ESLAVATH GANESH KUMAR	MBBS	Esavath
68	PANDHIPATI RAMYAPRIYA	MBBS.	Ramyapriya
69	GOLAMARI PRANAY PAUL REDDY	MBBS	Pranay
70	CHETANA MAHARANA	MBBS.	Chetana
71	RANOO PRIYAMBADA BISWAL	MBBS	Ranoo
72	KUKUDALA KEERTHI	MBBS	Keerthi
73	HAJIRA NOOREIN	MBBS.	Hajira
74	GRUSHA VARMA	MBBS	Varma
75	DURGAPPAGARI KIRANGOUD	MBBS	Kirango
76	DANUGURI UMA	MBBS	Danuguri
77	APPADI DIVYA	MBBS.	Divya
78	GIDDY RAM VARSHITH REDDY	MBBS	Varshith
79	KOTHAPALLI SAICHANDANA	MBBS.	Saichandana
80	POLE MOUNIKA	MBBS	Mounika
81	ADELLI SRIDHAR	MBBS	Sridhar
82	BHUKYA HARSHA	MBBS	Harsha
83	PERUMANDLA HANISHA	MBBS	Hanisha
84	GEENUKUNTA AMRUTH KUMAR	MBBS	Amruth
85	JOGINAPALLY GAYATHRI	MBBS.	Gayathri
86	GUNTOJU SUDEEP	MBBS	Sudeep
87	NUTALAPATI MOHAN KRISHNA	MBBS	Mohan Krishna

PRINCIPAL
MNR Medical College & Hospital
Fasalwadi, Sanga Reddy

Chairperson
Internal Quality Assurance Cell (IQAC)
MNR Medical College & Hospital



MNR MEDICAL COLLEGE & HOSPITAL

MNR Nagar, Fasalwadi, Sangareddy - 502 294, Sangareddy Dist. Telangana. India

Ph: + 85000 56667, (08455) 230523, 230527, 230524 Fax No. (08455) - 230555, 230533

88	PRANEESHA REDDY KANDI	MBBS	<i>Praneesha</i>
89	RAPAKA SHERLY	MBBS	<i>Sherly</i>
90	SHIVDUTT S KANDI	MBBS	<i>Shivdutt</i>
91	KADIYALA LIKHITHAA	MBBS	<i>Likhitha</i>
92	YEDIVALLY PRASHANTH REDDY	MBBS	<i>Prashanth</i>
93	NITIN SHARMA	MBBS	<i>Nitin</i>

Program Co-Ordinator
HOD

MN
PRINCIPAL

MNR Medical College & Hospital
Fasalwadi, Sanga Reddy

Chandana
Chairperson
Internal Quality Assurance Cell (IQAC)
MNR Medical College & Hospital



MNR MEDICAL COLLEGE & HOSPITAL

MNR Nagar, Fasalwadi, Sangareddy - 502 294, Sangareddy Dist. Telangana. India

Ph: + 85000 56667, (08455) 230523, 230527, 230524 Fax No. (08455) - 230555, 230533

FACULTY ATTENDANCE SHEET

Program Name: "Workshop on Biostatistics"

Date of activity: 17/07/2018

S.No	Name of the Faculty	Department	Signature
1	Dr. Sindhu	Gen Surg	[Signature]
2	Dr. N. Deepika	Ortho	[Signature]
3	Dr. Sunitha	Anatomy	[Signature]
4	Dr. Babu Rao	OPthal.	[Signature]
5	Dr. Bhavani	OBGY	[Signature]
6	Dr. Amarendra Prasada	Gen Surg	[Signature]
7	Dr. Anwar Yabon	Biochem	[Signature]
8	Dr. Nagababu	Biochem	[Signature]
9	Dr. Ilaiyah Yabon	Gen Surg	[Signature]
10	Dr. P. Surendra	Microbiology	[Signature]
11	Dr. Chandrasekar J.	Pathol	[Signature]

Program Co-Ordinator

HOD

Chairperson
Internal Quality Assurance Cell (IQAC)
MNR Medical College & Hospital

[Signature]
PRINCIPAL
MNR Medical College & Hospital
Fasalwadi, Sangareddy



MNR Medical College

Fasalwadi, Sangareddy, Hyderabad, Telangana-502 294.

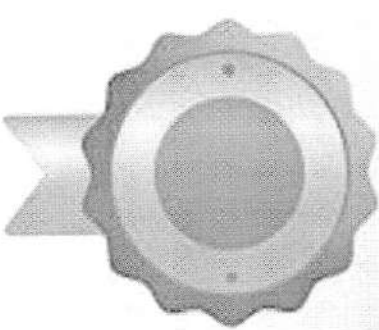

Certificate of Participation

This is to certify that

M. Manisha Goud.

has participated in A Workshop on

"Biostatistics"

ON **17/07/2018** organised by R&D Cell, conducted at MNR Medical College,
Fasalwadi, Sangareddy, Hyderabad, Telangana-502 294.

Chairperson

Internal Quality Assurance Cell (IQAC),
MNR Medical College & Hospital

PRINCIPAL

MNR Medical College & Hospital
Fasalwadi, Sangareddy-502294



MNR Medical College

Fasalwadi, Sangareddy, Hyderabad, Telangana-502 294.

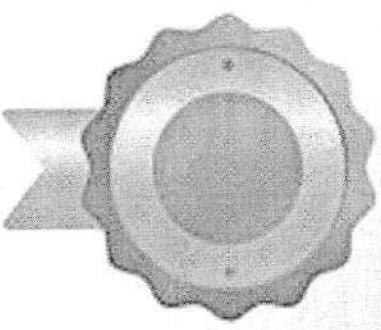

Certificate of Participation

THIS IS TO CERTIFY THAT

Malika Hossain

HAS PARTICIPATED IN A WORKSHOP ON

"Biostatistics"

ON **17/07/2018** ORGANISED BY R&D CELL, CONDUCTED AT MNR Medical College,
Fasalwadi, Sangareddy, Hyderabad, Telangana-502 294.

Chairperson
Internal Quality Assurance Cell (IQAC),
MNR Medical College & Hospital

PRINCIPAL
MNR Medical College & Hospital
Fasalwadi, Sangareddy-502294



MNR Medical College

Fasalwadi, Sangareddy, Hyderabad, Telangana-502 294.

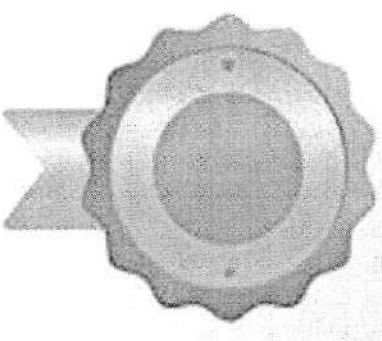

Certificate of Participation

THIS IS TO CERTIFY THAT

Dr. Rudra Prasad.

HAS PARTICIPATED IN A WORKSHOP ON

"Biostatistics"

ON **17/07/2018** ORGANISED BY R&D CELL, CONDUCTED AT MNR Medical College,
Fasalwadi, Sangareddy, Hyderabad, Telangana-502 294.

Chairperson
Internal Quality Assurance Cell (IQAC),
MNR **convene**
Medical College & Hospital

PRINCIPAL
MNR **Principal**
MEDICAL COLLEGE & HOSPITAL
FASALWADI, SANGAREDDY-502294



MNR Medical College

Fasalwadi, Sangareddy, Hyderabad, Telangana-502 294.

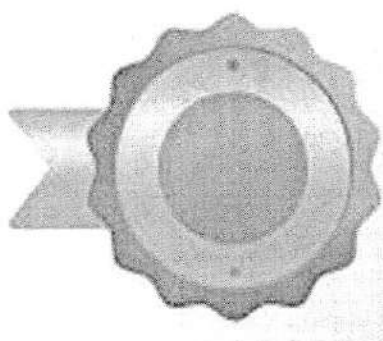

Certificate of Participation

THIS IS TO CERTIFY THAT

Dr Deepika.

HAS PARTICIPATED IN A WORKSHOP ON

"Biostatistics"

ON **17/07/2018** ORGANISED BY R&D CELL, CONDUCTED AT MNR Medical College,
Fasalwadi, Sangareddy, Hyderabad, Telangana-502 294.

Chairperson

Internal Quality Assurance Cell (IQAC),
MNR **convenor** Medical College & Hospital

PRINCIPAL

MNR **Principal** MEDICAL COLLEGE & HOSPITAL
FASALWADI, SANGAREDDY, 502294



MNR Medical College

Fasalwadi, Sangareddy, Hyderabad, Telangana-502 294.

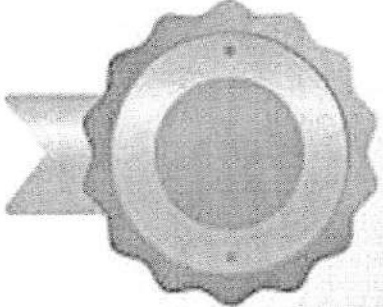

Certificate of Participation

THIS IS TO CERTIFY THAT

Dr. V.R. Srinivas

HAS PARTICIPATED IN A WORKSHOP ON

"Biostatistics"

ON 17/07/2018 ORGANISED BY R&D CELL, CONDUCTED AT MNR MEDICAL COLLEGE,
FASALWADI, SANGAREDDY, HYDERABAD, TELANGANA-502 294.

Chairperson
Internal Quality Assurance Cell (IQAC),
MNR Medical College & Hospital
convenor

PRINCIPAL
MNR MEDICAL COLLEGE & HOSPITAL
FASALWADI, SANGAREDDY-502294



MNR MEDICAL COLLEGE & HOSPITAL

MNR Nagar, Fasalwadi, Sangareddy - 502 294, Sangareddy Dist. Telangana. India

Ph: + 85000 56667, (08455) 230523, 230527, 230524 Fax No. (08455) - 230555, 230533

CIRCULAR

Date: 06-08-2018

All the staff members and students are invited for a workshop titled "Workshop on proper blood sample technique for technicians" to be conducted by the R&D Cell on 07-08-2018. The venue of the presentation is Demo Hall-II, and Laboratory Biochemistry. Please take this opportunity to enlighten yourself and enhance your career.



Principal

Copy to

- Medical Superintendent
- CEO
- Assistant Director
- Chief Academic Officer
- IQAC
- Concerned HODs
- Notice Boards

PRINCIPAL
MNR Medical College & Hospital
Fasalwadi, Sangareddy



Chairperson
Internal Quality Assurance Cell (IQAC)
MNR Medical College & Hospital



MNR MEDICAL COLLEGE & HOSPITAL

MNR Nagar, Fasalwadi, Sangareddy - 502 294, Sangareddy Dist. Telangana. India

Ph: + 85000 56667, (08455) 230523, 230527, 230524 Fax No. (08455) - 230555, 230533

Date: 22-08-2019

PROGRAM REPORT

Program Name: "Workshop on proper blood sample technique for technicians"

Date of activity: 07-08-2018

Venue: Demo Hall-II, and Laboratory Biochemistry

Organized by: R&D Cell

Resource person: Dr Anurag Yadav, Assist prof & Lab consultant, Department of Biochemistry, Father Muller Medical College, Mangalore.

Number of participants: 87 Students & 12 Faculty

Objective of the program

The main objective of the workshop is to make everyone aware and know about the Arterial blood sampling technique.

- Understand what ABG samples measure and how to interpret the result.
- Demonstrate an understanding of the anatomy of arteries.
- Perform and be aware of dangers and complications of this invasive technique.
- To safely work towards competence.

Contents Delivered

- Arterial Puncture
- Anatomy of arteries
- Complications in doing arterial blood sampling

Outcome of the program

The workshop is conducted to have an idea about "Arterial blood sampling technique" arterial blood sample is collected from an artery, primarily to determine arterial blood gases. Arterial blood sampling should only be performed by health workers for whom the procedure is in the legal scope of practice for their position in their country and who have demonstrated proficiency after formal training.

Chairperson
Internal Quality Assurance Cell (IQAC)
MNR Medical College & Hospital

PRINCIPAL
MNR Medical College & Hospital,
Fasalwadi, Sanga Reddy



MNR MEDICAL COLLEGE & HOSPITAL

MNR Nagar, Fasalwadi, Sangareddy - 502 294, Sangareddy Dist. Telangana. India

Ph: + 85000 56667, (08455) 230523, 230527, 230524 Fax No. (08455) - 230555, 230533



PRINCIPAL

MNR MEDICAL COLLEGE & HOSPITAL
FASALWADI, SANGAREDDY-502294

Program Co-Ordinator

HOD

Chairperson
Internal Quality Assurance Cell (IQAC)
MNR Medical College & Hospital

Chairperson
MEDICAL EDUCATION UNIT
MNR Medical College & Hospital



MNR MEDICAL COLLEGE & HOSPITAL

MNR Nagar, Fasalwadi, Sangareddy - 502 294, Sangareddy Dist. Telangana. India

Ph: + 85000 56667, (08455) 230523, 230527, 230524 Fax No. (08455) - 230555, 230533

S.No	Name of the participant	Course	Signature
1	YASHASREE PASUPULETI	MBBS	Y. Pasupuleti
2	SOMA NITISH REDDY	MBBS	Nitish
3	ROSHAN KUMAR M	MBBS	Roshan
4	BANDYALA SAIKUMAR	MBBS	Saikumar
5	NIKHITA NADIMPALLI	MBBS	NIKHITA
6	MUSKU NANDINI	MBBS	Musku
7	AKULA PALLAVI	MBBS	Pallavi
8	KONGALA RISHITHA	MBBS	Rishitha
9	GOLKONDA KARTHIK	MBBS	Karthik
10	BIRADAR SAIKUMAR	MBBS	Saikumar
11	NAIKOTI RAHUL	MBBS	Rahul
12	KOTHURU SUSHANTH	MBBS	Sushanth
13	SEVELLA MANOJ KUMAR	MBBS	Manoj
14	DANDYAR SHIVA PRASAD	MBBS	Shiva
15	BURRA JEEVANA	MBBS	Jeevana
16	MALELA BHANU PRASAD GOUD	MBBS	Bhanuprasad
17	AKKENAPALLY RAJASHEKARACHARY	MBBS	Rajeshkar
18	JANGITI MANEESHA	MBBS	Maneesha
19	BOLLOJU GURU PRASAD	MBBS	Guru Prasad
20	P SRILEKHA	MBBS	Srilekha
21	MORAM STOTRA PRIYA	MBBS	Priya
22	RACHANA RAPOLU	MBBS	Rachana
23	M MANISHA GOUD	MBBS	Manisha
24	OGGU SRIKANTH	MBBS	Srikanth
25	EDIGA SAI CHANDANA	MBBS	Sai Chandana
26	MARUGONDA SAKETH VARMA	MBBS	Saketh

MNR Medical College & Hospital
Fasalwadi, Sangareddy.

Chairperson
Internal Quality Assurance Cell (IQAC)
MNR Medical College & Hospital



MNR MEDICAL COLLEGE & HOSPITAL

MNR Nagar, Fasalwadi, Sangareddy - 502 294, Sangareddy Dist. Telangana. India

Ph: + 85000 56667, (08455) 230523, 230527, 230524 Fax No. (08455) - 230555, 230533

27	ANUMALLA MANASWINI	MBBS	Manaswini
28	BANDI NAVEEN KUMAR	MBBS	NK
29	SHAIK HASNAD BABA	MBBS	S.H. Koala
30	MAHEEN SULTANA	MBBS	Maheena
31	BANOTH VASANTH KUMAR	MBBS	Vasanth
32	B ANJALI NAIK	MBBS	Anjali
33	MALAGARI MANEESHA	MBBS	Maneisha
34	CHINMAYEE DESAI	MBBS	Chinmayee
35	GAJULA SRI HARSHA CHAKRAVARTHY	MBBS	Sri Harsha
36	MALKA HARSHITHA	MBBS	Harshitha
37	MENDI DEEKSHITHA	MBBS	Deekshitha
38	YATHAM SRI HARIKA	MBBS	Harika
39	J AISHWARYA	MBBS	Aishwarya
40	MUTHERAGALLA PRATHYUSHA	MBBS	Prathyusha
41	SEELAM LAXMI PRIYA	MBBS	Priya
42	BANDILA V V S TANMAIYEE	MBBS	Tanmai
43	GADDAM SRINIVAS	MBBS	Srinivas
44	SK AJEETH MUSHRAF	MBBS	Ajeeth
45	GAJULA CHANDRA HASA	MBBS	Chandray
46	SALADI SAI VENKATA SOWMYA SARADA	MBBS	Sowmya
47	SHRUTI BOSE	MBBS	Shruti
48	DODDIPALLI BHANU PRAKASH REDDY	MBBS	Bhanu
49	SABHADU SUSHMITHA	MBBS	Sushmitha
50	PRIYANKA RAJ KUMAWAT	MBBS	Raj
51	MUGA RITHIKA	MBBS	Rithika
52	R PRANITH KAMLAY	MBBS	Pranith
53	MARPALIKAR YOGESHWARI CHANDRAKANT	MBBS	Yogeshwari
54	RAJA RAJESWAR REDDY ATTLA	MBBS	Raja
55	NABAMITA CHAKRABORTY	MBBS	Nabamita
56	SHUBAM DILIP SHINDE	MBBS	Dilip

PRINCIPAL
MNR Medical College & Hospital
Fasalwadi, Sanga Reddy

Chairperson
Internal Quality Assurance Cell
MNR Medical College & Hospital



MNR MEDICAL COLLEGE & HOSPITAL

MNR Nagar, Fasalwadi, Sangareddy - 502 294, Sangareddy Dist. Telangana. India

Ph: + 85000 56667, (08455) 230523, 230527, 230524 Fax No. (08455) - 230555, 230533

57	BODDAM CHANDRALEKHA	MBBS	Chandralekha
58	ROHIT JAJU	MBBS	Rohit Raju
59	NABA KHANAM	MBBS	Nabakhanam
60	JAKAREGARI SOLOMON SUMAHITH SURATHAN	MBBS	Sumahith
61	AMBATI SAI KEERTHANA	MBBS	Keerthana
62	DAKSHA LONAVATH	MBBS	Daksha
63	ESLAVATH GANESH KUMAR	MBBS	Ganesh Kumar
64	PANDHIPATI RAMYAPRIYA	MBBS	Ramyapriya
65	GOLAMARI PRANAY PAUL REDDY	MBBS	Pranay
66	CHETANA MAHARANA	MBBS	Chetana
67	RANOO PRIYAMBADA BISWAL	MBBS	PRIYAMBADA
68	KUKUDALA KEERTHI	MBBS	Keerthi
69	HAJIRA NOOREIN	MBBS	Noorein
70	GRUSHA VARMA	MBBS	Grusha
71	DURGAPPAGARI KIRANGOUD	MBBS	Kirangoud
72	DANUGURI UMA	MBBS	Uma
73	APPADI DIVYA	MBBS	Varshith Reddy
74	GIDDY RAM VARSHITH REDDY	MBBS	Varshith
75	KOTHAPALLI SAICHANDANA	MBBS	Saichandana
76	POLE MOUNIKA	MBBS	Mounika
77	ADELLI SRIDHAR	MBBS	Sridhar
78	BHUKYA HARSHA	MBBS	Harsha
79	PERUMANDLA HANISHA	MBBS	Hanisha
80	GEENUKUNTA AMRUTH KUMAR	MBBS	Amruth
81	JOGINAPALLY GAYATHRI	MBBS	Gayathri
82	GUNTOJU SUDEEP	MBBS	Sudeep
83	NUTALAPATI MOHAN KRISHNA	MBBS	Mohana
84	PRANEESHA REDDY KANDI	MBBS	Praneesha
85	RAPAKA SHERLY	MBBS	Sherly
86	SHIVDUTT S KANDI	MBBS	Shivdutt
87	KADIYALA LIKHITHAA	MBBS	Likhitha

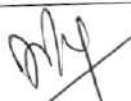
PRINCIPAL
MNR Medical College & Hospital
Fasalwadi, Sanga Reddy

Chairperson
Internal Quality Assurance Cell (IQAC)
MNR Medical College & Hospital



MNR MEDICAL COLLEGE & HOSPITAL

MNR Nagar, Fasalwadi, Sangareddy - 502 294, Sangareddy Dist. Telangana. India

Ph: + 85000 56667, (08455) 230523, 230527, 230524 Fax No. (08455) - 230555, 230533

FACULTY ATTENDANCE SHEET

Program Name: "Workshop on proper blood sample technique for technicians"

Date of activity: 07-08-2018

S.No	Name of the Faculty	Department	Signature
1	Dr. Babu Rao	Ophthalmology	Babu Rao
2	Dr. Rudraprasad	General Surgery	Rudra
3	Dr. Ilcibabu	General Medicine	Ilcibabu
4	Dr. Pushpakumari	General Medicine	Pushpa
5	Dr. Ravi Mandele	Pharmacology	Ravi
6	Dr. Vipul	Microbiology	Vipul
7	Dr. Lingaraj Loture	General Medicine	Lingaraj
8	Dr. P. Suresh	Microbiology	P. Suresh
9	Dr. Bhavani	OBGYN	Bhavani
10	Dr. Anand Babu	General Medicine	Anand
11	Dr. Nagababu	Biochem	Nagababu
12	Dr. Deepika	Ophthalmology	Deepika

Program Co-Ordinator

Chairperson
Internal Quality Assurance Cell (IQAC)
MNR Medical College & Hospital

HOD

PRINCIPAL
MNR Medical College & Hosp.
Fasalwadi, Sanga Reddy



MNR Medical College

Fasalwadi, Sangareddy, Hyderabad, Telangana-502 294.

Certificate of Participation

This is to certify that

ROSHAN KUMAR, M

has participated in A Workshop on

“Proper Blood Sample Technique for Technicians”

*on 07-08-2018 organised by R&D Cell, conducted at MNR Medical College,
Fasalwadi, Sangareddy, Hyderabad, Telangana-502 294.*

Chairperson

Internal Quality Assurance Cell (IQAC)
MNR Medical College & Hospital

Convener

Principal
PRINCIPAL

MNR MEDICAL COLLEGE & HOSPITAL
FASALWADI, SANGAREDDY-502294



MNR Medical College

Fasalwadi, Sangareddy, Hyderabad, Telangana-502 294.

Certificate of Participation

This is to certify that

BANDYALA SAIKUMAR

has participated in A Workshop on

“Proper Blood Sample Technique for Technicians”

*on 07-08-2018 organised by R&D Cell, conducted at MNR Medical College,
Fasalwadi, Sangareddy, Hyderabad, Telangana-502 294.*

Chairperson

Internal Quality Assurance Cell (IQAC)
MNR Medical College & Hospital

Convenor

Principal

MNR MEDICAL COLLEGE & HOSPITAL
FASALWADI, SANGAREDDY, 502294



MNR Medical College

Fasalwadi, Sangareddy, Hyderabad, Telangana-502 294.

Certificate of Participation

This is to certify that

KONGIALA RISHITHA

has participated in A Workshp on

“Proper Blood Sample Technique for Technicians”

on 07-08-2018 organised by R&D Cell, conducted at MNR Medical College,

Fasalwadi, Sangareddy, Hyderabad, Telangana-502 294.

Chairperson

Internal Quality Assurance Cell (IQAC)
MNR Medical College & Hospital

Convenor

Principal
PRINCIPAL

MNR MEDICAL COLLEGE & HOSPITAL
FASALWADI, SANGAREDDY-502294



MNR Medical College

Fasalwadi, Sangareddy, Hyderabad, Telangana-502 294.

Certificate of Participation

This is to certify that

Dr. PUSHPAKUMARI

has participated in A Workshop on

“Proper Blood Sample Technique for Technicians”
*on 07-08-2018 organised by R&D Cell, conducted at MNR Medical College,
Fasalwadi, Sangareddy, Hyderabad, Telangana-502 294.*



Chairperson
Internal Quality Assurance Cell (IQAC)
MNR Medical College & Hospital



Convener



Principal
MNR MEDICAL COLLEGE & HOSPITAL
FASALWADI, SANGAREDDY-502294



MNR Medical College

Fasalwadi, Sangareddy, Hyderabad, Telangana-502 294.

Certificate of Participation

This is to certify that

Dr. VIPULA

has participated in A Workshop on

“Proper Blood Sample Technique for Technicians”
*on 07-08-2018 organised by R&D Cell, conducted at MNR Medical College,
Fasalwadi, Sangareddy, Hyderabad, Telangana-502 294.*

Principal
PRINCIPAL

MNR MEDICAL COLLEGE & HOSPITAL
FASALWADI, SANGAREDDY-502294

Chairperson

Internal Quality Assurance Cell (IQAC)
MNR Medical College & Hospital



MNR Medical College

Fasalwadi, Sangareddy, Hyderabad, Telangana-502 294.

Certificate of Participation

This is to certify that

Dr. P. SURESH

has participated in A Workshop on

“Proper Blood Sample Technique for Technicians”
*on 07-08-2018 organised by R&D Cell, conducted at MNR Medical College,
Fasalwadi, Sangareddy, Hyderabad, Telangana-502 294.*



Chairperson

Internal Quality Assurance Cell (IQAC)
MNR Medical College & Hospital

Convenor



Principal
PRINCIPAL



MNR MEDICAL COLLEGE & HOSPITAL
FASALWADI, SANGAREDDY-502294



MNR MEDICAL COLLEGE & HOSPITAL

MNR Nagar, Fasalwadi, Sangareddy - 502 294, Sangareddy Dist. Telangana. India

Ph: + 85000 56667, (08455) 230523, 230527, 230524 Fax No. (08455) - 230555, 230533

CIRCULAR

Date: 11-09-2018

All the staff members and students are invited for a seminar titled "Seminar on how to avoid plagiarism" to be conducted by the R&D Cell on 12th September 2018. The venue of the presentation is Demo Hall-II, Biochemistry. Please take this opportunity to enlighten yourself and enhance your career.

Principal

Copy to

- Medical Superintendent
- CEO
- Assistant Director
- Chief Academic Officer
- IQAC
- Concerned HODs
- Notice Boards

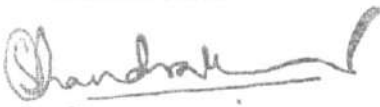
Chairperson
Internal Quality Assurance Cell (IQAC)
MNR Medical College & Hospital

PRINCIPAL
MNR Medical College & Hospital
Fasalwadi, Sangareddy



MNR MEDICAL COLLEGE & HOSPITAL

MNR Nagar, Fasalwadi, Sangareddy - 502 294, Sangareddy Dist. Telangana. India

Ph: + 85000 56667, (08455) 230523, 230527, 230524 Fax No. (08455) - 230555, 230533

Date: 13/09/2018

PROGRAM REPORT

Program Name: "Seminar on how to avoid plagiarism"

Date of activity: 12/09/2018

Venue: Demo Hall-II, Biochemistry

Organized by: R&D Cell

Resource person: Dr Anurag Yadav, Assist prof, Department of Biochemistry, Father Muller Medical College Mangalore.

Number of participants: 91 Students & 13 Faculty

Objective of the program

Prevention of plagiarism is related to achieving and maintaining originality and creativity as well as achieving and maintaining academic honesty. Plagiarism is an offense with adverse effects on reputation of the institution as well as the reputation and career of the person who plagiarize.

Contents Delivered

- Objectives of Research and relevance of Literature Review of Research
- Writing the quality research paper and choosing the appropriate journal

Outcome of the program

The participants of the Seminar will be able to understand the knowledge to convert the research outcome into paper writing and learned about plagiarism. The faculty members and students were benefitted massively from this seminar. The seminar motivated the aspiring researchers and also helped the Ph.D holders to update themselves. This institute looks forward to conduct multiple informative seminars on research like this in near future.

Chairperson
Internal Quality Assurance Cell (IQAC)



PRINCIPAL
MNR Medical College & Hospital
Fasalwadi, Sanga Reddy



MNR MEDICAL COLLEGE & HOSPITAL

MNR Nagar, Fasalwadi, Sangareddy - 502 294, Sangareddy Dist. Telangana. India

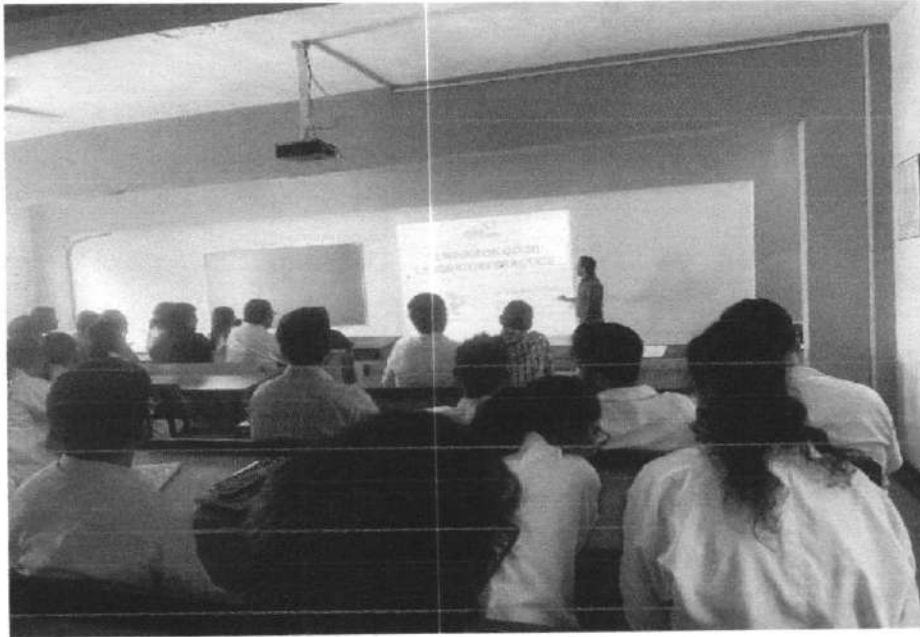
Ph: + 85000 56667, (08455) 230523, 230527, 230524 Fax No. (08455) - 230555, 230533



PRINCIPAL

MNR MEDICAL COLLEGE & HOSPITAL
FASALWADI, SANGAREDDY-502294

Chairperson
Internal Quality Assurance Cell (IQAC)
MNR Medical College & Hospital

Chairperson
MEDICAL EDUCATION UNIT
MNR Medical College & Hospital



MNR MEDICAL COLLEGE & HOSPITAL

MNR Nagar, Fasalwadi, Sangareddy - 502 294, Sangareddy Dist. Telangana. India

Ph: + 85000 56667, (08455) 230523, 230527, 230524 Fax No. (08455) - 230555, 230533

Date of activity: 12/09/2018

S.No	Name of the participant	Course	Signature
1	YASHASREE PASUPULETI	MBBS	Yashashree
2	SOMA NITISH REDDY	MBBS	Nitish
3	ROSHAN KUMAR M	MBBS	Roshan
4	BANDYALA SAIKUMAR	MBBS	Kan
5	NIKHITA NADIMPALLI	MBBS	Nikhitha
6	MUSKU NANDINI	MBBS	Nandini.
7	AKULA PALLAVI	MBBS	Pallavi
8	KONGALA RISHITHA	MBBS	Rishitha
9	GOLKONDA KARTHIK	MBBS	Karthik
10	BIRADAR SAIKUMAR	MBBS	Sai
11	NAIKOTI RAHUL	MBBS	Rahul.
12	KOTHURU SUSHANTH	MBBS	Sushanth
13	SEVELLA MANOJ KUMAR	MBBS	Manoj
14	DANDYAR SHIVA PRASAD	MBBS	Shiva
15	BURRA JEEVANA	MBBS	Jeevana
16	MALELA BHANU PRASAD GOUD	MBBS	Bhanu
17	AKKENAPALLY RAJASHEKARACHARY	MBBS	Rajasekar
18	JANGITI MANEESHA	MBBS	Maneesha
19	BOLLOJU GURU PRASAD	MBBS	Guru
20	P SRILEKHA	MBBS	P. Sritekha.
21	MORAM STOTRA PRIYA	MBBS	Priya
22	RACHANA RAPOLU	MBBS	Rachana
23	M MANISHA GOUD	MBBS	Manisha
24	OGGU SRIKANTH	MBBS	Srikanth
25	EDIGA SAI CHANDANA	MBBS	Saichandana

PRINCIPAL
MNR Medical College & Hospital
Fasalwadi, Sangareddy

Chairperson
Internal Quality Assurance Cell (IQAC)
MNR Medical College & Hospital



MNR MEDICAL COLLEGE & HOSPITAL

MNR Nagar, Fasalwadi, Sangareddy - 502 294, Sangareddy Dist. Telangana. India

Ph: + 85000 56667, (08455) 230523, 230527, 230524 Fax No. (08455) - 230555, 230533

26	MARUGONDA SAKETH VARMA	MBBS	Saketh
27	ANUMALLA MANASWINI	MBBS	Manaswini
28	BANDI NAVEEN KUMAR	MBBS	Naveen
29	SHAIK HASNAD BABA	MBBS	Hasnad
30	MAHEEN SULTANA	MBBS	Maheen
31	BANOTH VASANTH KUMAR	MBBS	Vasanth
32	B ANJALI NAIK	MBBS	Anjali
33	MALAGARI MANEESHA	MBBS	Maneesh
34	CHINMAYEE DESAI	MBBS	Chinmayee
35	GAJULA SRI HARSHA CHAKRAVARTHY	MBBS	Harsha
36	MALKA HARSHITHA	MBBS	Harshitha
37	MENDI DEEKSHITHA	MBBS	Deekshitha
38	YATHAM SRI HARIKA	MBBS	Harika
39	J AISHWARYA	MBBS	Aishwarya
40	MUTHERAGALLA PRATHYUSHA	MBBS	Prathyusha
41	SEELAM LAXMI PRIYA	MBBS	Priya
42	BANDILA V V S TANMAIYEE	MBBS	Tanmaiye
43	GADDAM SRINIVAS	MBBS	Srinivas
44	SK AJEETH MUSHRAF	MBBS	Ajeeth
45	GAJULA CHANDRA HASA	MBBS	Chandra
46	SALADI SAI VENKATA SOWMYA SARADA	MBBS	Sarada
47	SHRUTI BOSE	MBBS	Shruti
48	DODDIPALLI BHANU PRAKASH REDDY	MBBS	Bhanu
49	SABHADU SUSHMITHA	MBBS	Sushmitha
50	PRIYANKA RAJ KUMAWAT	MBBS	Priyanka
51	MUGA RITHIKA	MBBS	Muga Rithika
52	R PRANITH KAMLAY	MBBS	Pranith
53	MARPALIKAR YOGESHWARI CHANDRAKANT	MBBS	Yogeshwari
54	RAJA RAJESWAR REDDY ATTLA	MBBS	Raja
55	NABAMITA CHAKRABORTY	MBBS	Ch. Nabamita

PRINCIPAL
MNR Medical College & Hospital
Fasalwadi, Sangareddy, Telangana

Internal Quality Assurance Cell (IQAC)
MNR Medical College & Hospital



MNR MEDICAL COLLEGE & HOSPITAL

MNR Nagar, Fasalwadi, Sangareddy - 502 294, Sangareddy Dist. Telangana. India

Ph: + 85000 56667, (08455) 230523, 230527, 230524 Fax No. (08455) - 230555, 230533

56	SHUBAM DILIP SHINDE	MBBS	Dilip
57	BODDAM CHANDRALEKHA	MBBS	Chendrabehn
58	ROHIT JAJU	MBBS	Rohit
59	NABA KHANAM	MBBS	Naba Khanam
60	JAKAREGARI SOLOMON SUMAHITH SURATHAN	MBBS	Sumahith
61	AMBATI SAI KEERTHANA	MBBS	Sai Keerthana
62	DAKSHA LONAVATH	MBBS	Daksha L
63	ESLAVATH GANESH KUMAR	MBBS	Ganesh
64	PANDHIPATI RAMYAPRIYA	MBBS	Ramyapriya
65	GOLAMARI PRANAY PAUL REDDY	MBBS	Pranay
66	CHETANA MAHARANA	MBBS	M. Chetna
67	RANOO PRIYAMBADA BISWAL	MBBS	Priya
68	KUKUDALA KEERTHI	MBBS	Keerthi
69	HAJIRA NOOREIN	MBBS	Hajira
70	GRUSHA VARMA	MBBS	Grusha Varma
71	DURGAPPAGARI KIRANGOUD	MBBS	Kiran
72	DANUGURI UMA	MBBS	Uma
73	APPADI DIVYA	MBBS	Appadi Divya
74	GIDDIY RAM VARSHITH REDDY	MBBS	Ram
75	KOTHAPALLI SAICHANDANA	MBBS	Chandana
76	POLE MOUNIKA	MBBS	Mounika
77	ADELLI SRIDHAR	MBBS	Sridhar
78	BHUKYA HARSHA	MBBS	Harsha
79	PERUMANDLA HANISHA	MBBS	P. Hanisha
80	GEENUKUNTA AMRUTH KUMAR	MBBS	Amruth
81	JOGINAPALLY GAYATHRI	MBBS	Gayathri
82	GUNTOJU SUDEEP	MBBS	Sudeep
83	NUTALAPATI MOHAN KRISHNA	MBBS	Mohan
84	PRANEESHA REDDY KANDI	MBBS	Praneesha
85	RAPAKA SHERLY	MBBS	R. Sherly
86	SHIVDUTT S KANDI	MBBS	Shivdutt
87	KADIYALA LIKHITHAA	MBBS	Likhitha

Principal
MNR Medical College & Hospital
Fasalwadi, Sangareddy

Chairperson
Internal Quality Assurance
MNR Medical College & Hospital



MNR MEDICAL COLLEGE & HOSPITAL

MNR Nagar, Fasalwadi, Sangareddy - 502 294, Sangareddy Dist. Telangana. India

Ph: + 85000 56667, (08455) 230523, 230527, 230524 Fax No. (08455) - 230555, 230533

88	YEDIVALLY PRASHANTH REDDY	MBBS	Prashanth
89	NITIN SHARMA	MBBS	Nitin
90	SAGGIDI NIKITHA	MBBS	Nikitha
91	PR RAJA RAMA CHANDRA REDDY	MBBS	Rama

PRINCIPAL
MNR Medical College & Hospital
Fasalwadi, Sangareddy

Program Co-Ordinator
HOD

Chairperson
Internal Quality Assurance Cell (IQAC)
MNR Medical College & Hospital

FACULTY ATTENDANCE SHEET

Program Name: "Seminar on how to avoid plagiarism"

Date of activity: 12/09/2018

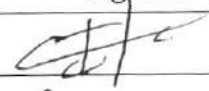
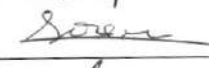
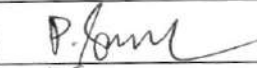
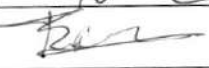
S.No	Name of the Faculty	Department	Signature
1	Dr. Harial Yasu	Gen med	
2	Dr. Sreenivas	Gen med	
3	Dr. P. Suresh	Microbiology	
4	Dr. Pushpakumari	Gen med	



MNR MEDICAL COLLEGE & HOSPITAL

MNR Nagar, Fasalwadi, Sangareddy - 502 294, Sangareddy Dist. Telangana. India

Ph: + 85000 56667, (08455) 230523, 230527, 230524 Fax No. (08455) - 230555, 230533

5	Dr. Bhavani	OBGY	Bhavani
6	Dr. Nagababu	Biochem	Nagababu
7	Dr. Anand	Gen Surg	Anand
8	Dr. Umesh	OBGY	Umesh
9	Dr. Keerthi	Gen med	Keerthi
10	Dr. Babu Rao	Ophthalm	Babu Rao
11	Dr. Sunitha	Anatomy	Sunitha
12	Dr. Sudha	OBGY	Sudha
13	Dr. Kaethik	Gen. Surg	Kaethik

Program Co-Ordinator
HOD

Chairman
Internal Quality Assurance Cell (IQAC)
MNR Medical College & Hospital

PRINCIPAL
MNR Medical College & Hospital
Fasalwadi, Sangareddy



MNR Medical College

Fasalwadi, Sangareddy, Hyderabad, Telangana-502 294.

Certificate of Participation

This is to certify that

Shruti Bose

has participated in A Seminar on

“How to Avoid Plagiarism”

*on 12/09/2018 organised by R&D Cell, conducted at MNR Medical College,
Fasalwadi, Sangareddy, Hyderabad, Telangana-502 294.*



Chairperson

Internal Quality Assurance Cell (IQAC)
MNR Medical College & Hospital



Convener



Principal

MNR MEDICAL COLLEGE & HOSPITAL
FASALWADI, SANGAREDDY 502294



MNR Medical College

Fasalwadi, Sangareddy, Hyderabad, Telangana-502 294.

Certificate of Participation

This is to certify that

Anjali Nait

has participated in A Seminar on

“How to Avoid Plagiarism”

*on 12/09/2018 organised by R&D Cell, conducted at MNR Medical College,
Fasalwadi, Sangareddy, Hyderabad, Telangana-502 294.*

Chairperson

Internal Quality Assurance Cell (IQAC)
MNR Medical College & Hospital

Convener

Principal

MNR MEDICAL COLLEGE & HOSPITAL
FASALWADI, SANGAREDDY, 502294



MNR Medical College

Fasalwadi, Sangareddy, Hyderabad, Telangana-502 294.

Certificate of Participation

This is to certify that

M. Harshitha

has participated in A Seminar on

“How to Avoid Plagiarism”

*on 12/09/2018 organised by R&D Cell, conducted at MNR Medical College,
Fasalwadi, Sangareddy, Hyderabad, Telangana-502 294.*

Principal

Convener

[Signature]
Chairperson

Internal Quality Assurance Cell (IQAC)
MNR Medical College & Hospital

Principal

MNR MEDICAL COLLEGE & HOSPITAL
FASALWADI, SANGAREDDY 502294

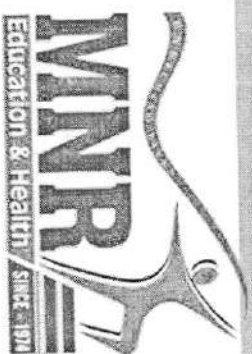

MNR Medical College

Fasalwadi, Sangareddy, Hyderabad, Telangana-502 294.

Certificate of Participation

This is to certify that

Dr. Pushpa Kumar

has participated in A Seminar on

“How to Avoid Plagiarism”

*on 12/09/2018 organised by R&D Cell, conducted at MNR Medical College,
Fasalwadi, Sangareddy, Hyderabad, Telangana-502 294.*

Chairperson

Internal Quality Assurance Cell (IQAC)
MNR Medical College & Hospital

Convener

Principal

MNR MEDICAL COLLEGE & HOSPITAL
FASALWADI, SANGAREDDY 502294



MNR Medical College

Fasalwadi, Sangareddy, Hyderabad, Telangana-502 294.

Certificate of Participation

This is to certify that

Dr. Tejal Yadav

has participated in A Seminar on

“How to Avoid Plagiarism”

*on 12/09/2018 organised by R&D Cell, conducted at MNR Medical College,
Fasalwadi, Sangareddy, Hyderabad, Telangana-502 294.*

Chairperson

Internal Quality Assurance Cell (IQAC)
MNR Medical College & Hospital

Convener

Principal

MNR MEDICAL COLLEGE & HOSPITAL
FASALWADI, SANGAREDDY 502294



MNR Medical College

Fasalwadi, Sangareddy, Hyderabad, Telangana-502 294.

Certificate of Participation

This is to certify that

Dr. Babu Rao

has participated in A Seminar on

“How to Avoid Plagiarism”

*on 12/09/2018 organised by R&D Cell, conducted at MNR Medical College,
Fasalwadi, Sangareddy, Hyderabad, Telangana-502 294.*

Chairperson

Internal Quality Assurance Cell (IQAC)
MNR Medical College & Hospital

Convener

Principal

MNR MEDICAL COLLEGE & HOSPITAL
FASALWADI, SANGAREDDY, TELANGANA-502294



MNR MEDICAL COLLEGE & HOSPITAL

MNR Nagar, Fasalwadi, Sangareddy - 502 294, Sangareddy Dist. Telangana. India

Ph: + 85000 56667, (08455) 230523, 230527, 230524 Fax No. (08455) - 230555, 230533

CIRCULAR

Date: 15-10-2018

All the staff members and students are invited for a seminar titled "Seminar on Route map for NABH" to be conducted by the R&D Cell on 16th October 2018. The venue of the presentation is Lecture Hall-III. Please take this opportunity to enlighten yourself and enhance your career.

Principal

Copy to

- Medical Superintendent
- CEO
- Assistant Director
- Chief Academic Officer
- IQAC
- Concerned HODs
- Notice Boards

PRINCIPAL
MNR Medical College & Hospital
Fasalwadi, Sangareddy

Chairperson
Internal Quality Assurance Cell (IQAC)
MNR Medical College & Hospital



MNR MEDICAL COLLEGE & HOSPITAL

MNR Nagar, Fasalwadi, Sangareddy - 502 294, Sangareddy Dist. Telangana. India

Ph: + 85000 56667, (08455) 230523, 230527, 230524 Fax No. (08455) - 230555, 230533

Date: 17/10/2018

PROGRAM REPORT

Program Name: "Seminar on Route map for NABH"

Date of activity: 16/10/2018

Venue: Lecture Hall-III

Organized by: R&D Cell

Resource person: Dr Ravi Kumar G, Lab Consultant, Ministry of Health Hospital Kingdom of Saudi Arabia.

Number of participants: 91 Students & 13 Faculty

Objective of the program

The objective of NABH is enhancing health system & promoting continuous quality improvement and patient safety.

Contents Delivered

- Organizational Structure
- Benefits of Accreditation
- NABH Standards for CLINIC-Allopathy

Outcome of the program

The participants of the Seminar will be able to understand National Accreditation Board for Hospitals and Healthcare Providers (NABH) is a constituent board of Quality Council of India (QCI), set up to establish and operate accreditation program for healthcare organizations. The board is structured to cater to much desired needs of the consumers and to set benchmarks for progress of health industry. The board while being supported by all stakeholders including industry, consumers, government, has full functional autonomy in its operation.

MNR N
Fasalwadi, Sangareddy
PRINCIPAL & Hospital
Dr. J. Reddy

Internal Quality Assurance Cell
MNR Medical College & Hospital



MNR MEDICAL COLLEGE & HOSPITAL

MNR Nagar, Fasalwadi, Sangareddy - 502 294, Sangareddy Dist. Telangana. India

Ph: + 85000 56667, (08455) 230523, 230527, 230524 Fax No. (08455) - 230555, 230533



Program Co-Ordinator

HOD

PRINCIPAL
MNR MEDICAL COLLEGE & HOSPITAL
FASALWADI, SANGAREDDY-502294

Chairperson
Internal Quality Assurance Cell (IQAC)
MNR Medical College & Hospital

Chairperson
MEDICAL EDUCATION UNIT
MNR Medical College & Hospital



MNR MEDICAL COLLEGE & HOSPITAL

MNR Nagar, Fasalwadi, Sangareddy - 502 294, Sangareddy Dist. Telangana. India

Ph: + 85000 56667, (08455) 230523, 230527, 230524 Fax No. (08455) - 230555, 230533

STUDENT ATTENDANCE SHEET

Program Name: "Seminar on Route map for NABH"

Date of activity: 16/10/2018

S.No	Name of the participant	Course	Signature
1	BHEEMAVARAPU SAI SIVANI REDDY	MBBS	Sivani
2	VEMURI MOHANCHANDRA BALAJI	MBBS	Balaji V.M
3	TATIKONDA MEGHANA MANI CHANDANA	MBBS	Meghana
4	VALLOORI SRUSTI GRISELDA	MBBS	Srusthi
5	AMTUL BASEER WAHEED	MBBS	Waheed
6	G.SPANDANA	MBBS	Spandana
7	CHANTI TEJA	MBBS	Teja
8	D R NIHARIKA	MBBS	Niharika
9	THOTA SUHARSHITHA	MBBS	Suharshitha
10	MEDASANI CHINMAI	MBBS	Chinmai
11	SUGOOR VAISHNAVI REDDY	MBBS	Sugoor
12	KATUKURI AKHIL REDDY	MBBS	Akhil
13	P.PRAVALIKA	MBBS	Pravalika
14	ILLENDULA NAGALALITYA	MBBS	Nagala
15	P.ALEKYA CHOUDARY	MBBS	Alekya
16	CHELLOJU MAHESH	MBBS	Mahesh
17	KASULA LIKHITHA	MBBS	Likhitha
18	KIRTY BATTULA	MBBS	Kirty
19	MOHD MOHSIN	MBBS	Mohsin
20	M VIGNESWARI	MBBS	Vigneswari

PRINCIPAL
MNR Medical College & Hospital
Fasalwadi, Sangareddy

Chairperson
Internal Quality Assurance Cell (IQAC)
MNR Medical College & Hospital



MNR MEDICAL COLLEGE & HOSPITAL

MNR Nagar, Fasalwadi, Sangareddy - 502 294, Sangareddy Dist. Telangana. India

Ph: + 85000 56667, (08455) 230523, 230527, 230524 Fax No. (08455) - 230555, 230533

21	SOMASANI VISHAL	MBBS	Vishal
22	AODARI AKSHITH	MBBS	Akshith
23	BHARATH CHANDRA KONDRU	MBBS	Bharath
24	INTI MOUNIKA	MBBS	Mounika
25	KANCHARLA SAMVEDA	MBBS	Samveda
26	H PRITHVI	MBBS	Prithvi
27	G MEDHA	MBBS	Medha
28	AKSHAY KULKARNI	MBBS	Akshay
29	KONDRAJU JAYASRI MAHESHWARI	MBBS	Jayasri
30	KONDA KEERTHANA	MBBS	Keerthana
31	SIRIPURAPU CHANDRAHAAS	MBBS	Siri
32	DOOSA KEERTHANA	MBBS	Keerthana
33	JANGITI SHIVANI	MBBS	Shivani
34	DORNALA SAI TEJA	MBBS	Sai Teja
35	NIMMAKURI SOWMYASRI	MBBS	Sowmya
36	KATHERVATH TARUN	MBBS	Tarun
37	RATHLA PARLAL	MBBS	Rathla Parlal
38	SAMMETA SRAVANI	MBBS	Sravani
39	NADIMPALLY HARSHITH REDDY	MBBS	Harshith
40	MOGURAM VAMSHI	MBBS	Vamsi
41	PAGIDI VANI	MBBS	Vani
42	SEELAM SUYUKTHA	MBBS	Suyuktha
43	KOLAGATLA BHAGYASRI	MBBS	Bhagavathi
44	BOMMANAPALLY INDIRA PRIYA DARSHINI	MBBS	Darshini
45	JAHNAVI PAKALAPATI	MBBS	Jahnavi
46	LAVUDI SANDHYA	MBBS	Sandhya
47	WALAKAYALA AISHWARYA	MBBS	Aishwarya

MNR
PRINCIPAL
MNR Medical College & Hospital
Fasalwadi, Sangareddy

Chairperson
Internal Quality Assurance Cell (IQAC)
MNR Medical College & Hospital



MNR MEDICAL COLLEGE & HOSPITAL

MNR Nagar, Fasalwadi, Sangareddy - 502 294, Sangareddy Dist. Telangana. India

Ph: + 85000 56667, (08455) 230523, 230527, 230524 Fax No. (08455) - 230555, 230533

48	MALLEKHEDI BHAVANA SRAVANTHI	MBBS	Bhavana
49	D. JAHNAVI	MBBS	Jahnavi
50	AASHRITHA VANGARI	MBBS	Aashritha
51	TIPPARAJU NITHINSREE	MBBS	Nithinsree
52	ESHIKA DEVINENI	MBBS	Devineni
53	LEBAKA VYSHNAVI	MBBS	Vyshnavi
54	SANKET RAJENDRA BHISE	MBBS	Sanket
55	DASARI RITHIKA REDDY	MBBS	Rithika
56	SANDEEP REDDY PUCHAKAYALA	MBBS	Sandeep
57	HIMA M	MBBS	Hima M
58	BERI RITHVIKA	MBBS	Rithvika
59	K NANDIKA	MBBS	Nandika
60	K. SHARATH KUMAR	MBBS	Sharath
61	YERVA MYTHILI	MBBS	Mythili
62	GODAS RAJESH	MBBS	Rajesh
63	CHINTA CHANDRA SEKHAR REDDY	MBBS	Chandra Sekhar
64	KATLA VINAY KUMAR	MBBS	Vinay Kumar
65	JINCY MOHAN M.G.	MBBS	Mohan
66	DEEKSHITHA OBIREDDY	MBBS	Deekshitha
67	JAY KISHAN BHATI	MBBS	Kishan
68	KORIVI AKSHARA PREETHI	MBBS	Akshara
69	SIRUPA LAHARI	MBBS	Lahari
70	VANKAMAMIDI BALA KEERTHANA	MBBS	Keerthana
71	PUPPALA HARSHINI	MBBS	Harshini
72	GUGULOTH NEETU CHARAN	MBBS	Charan
73	JARUPULA GREESHMA	MBBS	Greeshma
74	PADMAJA SAI GATIGANTI	MBBS	Padmaja
75	VELAGAPUDI SAI KISHAN	MBBS	Sai Kishan
76	BHARGAVA REDDY PALLAKI	MBBS	Pallaki
77	SAJJANAPU AISHWARYA	MBBS	Aishwarya

PRINCIPAL
MNR Medical College & Hospital
Fasalwadi, Sangareddy

Chairperson
Internal Quality Assurance Cell (IQAC)
MNR Medical College & Hospital



MNR MEDICAL COLLEGE & HOSPITAL

MNR Nagar, Fasalwadi, Sangareddy - 502 294, Sangareddy Dist. Telangana. India

Ph: + 85000 56667, (08455) 230523, 230527, 230524 Fax No. (08455) - 230555, 230533

78	GUTTEDAR MEGHA VERONICA	MBBS	Megha Veronice
79	ANGIREKULA SREEJA	MBBS	Sreeja.
80	EDALA NIKESH KUMAR	MBBS	Nikesh Kumar.
81	SUGURU VENKATA SATHYA KAUSTHUB	MBBS	Kausthub
82	KATAKAM PRIYESH REDDY	MBBS	Priyash
83	T. AKANKSHA	MBBS	Akanksha
84	GOLLA MANASA	MBBS	Manasa
85	BANDARU LALASA SWETHA	MBBS	Lalasa Swetha
86	ABBA RAVEENA	MBBS	Raveena
87	AYYAGARI SINDHU	MBBS	Sindhu
88	KATARI ASHRITH	MBBS	Ashrith.
89	KOLACHALA KAMESWARI SAI CHETALI	MBBS	Chetali
90	VAISHNAVI TALLURI	MBBS	Vaishnavi
91	BHANDAR DIVYA	MBBS	Divya

Program Co-Ordinator

PRINCIPAL
MNR Medical College & Hospital
Fasalwadi, Sanga Reddy

HOD

Chairperson
Internal Quality Assurance Cell (IQAC)
MNR Medical College & Hospital



MNR MEDICAL COLLEGE & HOSPITAL

MNR Nagar, Fasalwadi, Sangareddy - 502 294, Sangareddy Dist. Telangana. India

Ph: + 85000 56667, (08455) 230523, 230527, 230524 Fax No. (08455) - 230555, 230533

FACULTY ATTENDANCE SHEET

Program Name: "Seminar on Route map for NABH"

Date of activity: 16/10/2018

S.No	Name of the Faculty	Department	Signature
1	Dr. Indira	Geny medicine	[Signature]
2	Dr. Nagababu	Biochemistry	Nagababu
3	Dr. N. Deepika	OPHTH	[Signature]
4	Dr. Pavan K	Proctology	[Signature]
5	Dr. Sindhu	Geny medicine	[Signature]
6	Dr. Itan Yadav	General surgery	[Signature]
7	Dr. Bhavani	OBGY	Bhavani
8	Dr. Suni Sivani	Geny medicine	Suni
9	Dr. Anandha Prasad	Geny surgery	[Signature]
10	Dr. Sunitha	Anatomy	Sunitha
11	Dr. Chandrakumar S	Pathology	[Signature]
12	Dr. Babu Rao	OPHTH	Babu Rao
13	Dr. P. Suresh	Microbiology	P. Suresh

[Signature]
PRINCIPAL
MNR Medical College & Hospital
Fasalwadi, Sangareddy

[Signature]
Chairperson
Internal Quality Assurance Cell (IQAC)
MNR Medical College & Hospital



MNR MEDICAL COLLEGE & HOSPITAL

MNR Nagar, Fasalwadi, Sangareddy - 502 294, Sangareddy Dist. Telangana. India

Ph: + 85000 56667, (08455) 230523, 230527, 230524 Fax No. (08455) - 230555, 230533

Program Co-Ordinator

HOD

PRINCIPAL
MNR Medical College & Hospital
Fasalwadi, Sangareddy

Chairperson
Internal Quality Assurance Cell (IQAC)
MNR Medical College & Hospital



MNR Medical College

Fasalwadi, Sangareddy, Hyderabad, Telangana-502 294.

Certificate of Participation

This is to certify that

Dr. Suresh . P

has participated in A Seminar on
“Route Map for NABH”

*on 16/10/2018 organised by RRB Cell, conducted at MNR Medical College,
Fasalwadi, Sangareddy, Hyderabad, Telangana-502 294.*

[Signature]

Chairperson

Internal Quality Assurance Cell (IQAC)
MNR Medical College & Hospital

Convenor

[Signature]
Principal
PRINCIPAL

MNR MEDICAL COLLEGE & HOSPITAL
FASALWADI, SANGAREDDY-502294



MNR Medical College

Fasalwadi, Sangareddy, Hyderabad, Telangana-502 294.

Certificate of Participation

This is to certify that

B. Sai Sivani Reddy

has participated in A Seminar on

“Route Map for NABH”

*on 16/10/2018 organised by RRD Cell, conducted at MNR Medical College,
Fasalwadi, Sangareddy, Hyderabad, Telangana-502 294.*

Chairperson

Internal Quality Assurance Cell (IQAC)

MNR Medical College & Hospital

Convener

Principal
PRINCIPAL

MNR MEDICAL COLLEGE & HOSPITAL
FASALWADI, SANGAREDDY-502294



MNR Medical College

Fasalwadi, Sangareddy, Hyderabad, Telangana-502 294.

Certificate of Participation

This is to certify that

Pythagari Sindhu

has participated in A Seminar on

“Route Map for NABH”

*on 16/10/2018 organised by RRD Cell, conducted at MNR Medical College,
Fasalwadi, Sangareddy, Hyderabad, Telangana-502 294.*

Chairperson
Convener

Internal Quality Assurance Cell (IQAC)
MNR Medical College & Hospital

Principal
PRINCIPAL

MNR MEDICAL COLLEGE & HOSPITAL
FASALWADI, SANGAREDDY-502294



MNR Medical College

Fasalwadi, Sangareddy, Hyderabad, Telangana-502 294.

Certificate of Participation

This is to certify that

B. Indira Priya Darshini

has participated in A Seminar on
“Route Map for NABH”

*on 16/10/2018 organised by R D D Bell, conducted at MNR Medical College,
Fasalwadi, Sangareddy, Hyderabad, Telangana-502 294.*

[Signature]
Convener

[Signature]
Principal
PRINCIPAL

Chairperson
Internal Quality Assurance (Cell (IQAC))
MNR Medical College & Hospital

MNR MEDICAL COLLEGE & HOSPITAL
FASALWADI, SANGAREDDY-502294



MNR Medical College

Fasalwadi, Sangareddy, Hyderabad, Telangana-502 294.

Certificate of Participation

This is to certify that

Dr - Bhavani

has participated in A Seminar on
“Route Map for NABH”

*on 16/10/2018 organised by RTO Bell, conducted at MNR Medical College,
Fasalwadi, Sangareddy, Hyderabad, Telangana-502 294.*

Chairperson

Internal Quality Assurance Cell (IQAC)
MNR Medical College & Hospital

Principal

MNR MEDICAL COLLEGE & HOSPITAL
FASALWADI, SANGAREDDY-502294



MNR Medical College

Fasalwadi, Sangareddy, Hyderabad, Telangana-502 294.

Certificate of Participation

This is to certify that

Dr. Chandra Kumar

has participated in A Seminar on
“Route Map for NABH”

*on 16/10/2018 organised by RTO Cell, conducted at MNR Medical College,
Fasalwadi, Sangareddy, Hyderabad, Telangana-502 294.*

[Signature]
Convener

[Signature]
Principal
Principal

MNR MEDICAL COLLEGE & HOSPITAL
FASALWADI, SANGAREDDY-502294

Chairperson
Internal Quality Assurance Cell (IQAC)
MNR Medical College & Hospital



MNR MEDICAL COLLEGE & HOSPITAL

MNR Nagar, Fasalwadi, Sangareddy - 502 294, Sangareddy Dist. Telangana. India

Ph: + 85000 56667, (08455) 230523, 230527, 230524 Fax No. (08455) - 230555, 230533

CIRCULAR

Date: 10-12-2018

All the staff members and students are invited for a seminar titled "Seminar on Route map for NABL" to be conducted by the R&D Cell on 11th December 2018. The venue of the presentation is Lecture Hall-III. Please take this opportunity to enlighten yourself and enhance your career.

Principal

Copy to

- Medical Superintendent
- CEO
- Assistant Director
- Chief Academic Officer
- IQAC
- Concerned HODs
- Notice Boards

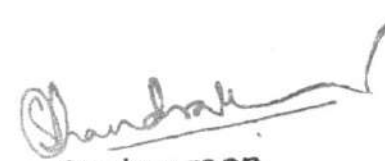
Chairperson
Internal Quality Assurance Cell (IQAC)
MNR Medical College & Hospital

PRINCIPAL
MNR Medical College & Hospital
Fasalwadi, Sanga Reddy



MNR MEDICAL COLLEGE & HOSPITAL

MNR Nagar, Fasalwadi, Sangareddy - 502 294, Sangareddy Dist. Telangana. India

Ph: + 85000 56667, (08455) 230523, 230527, 230524 Fax No. (08455) - 230555, 230533

Date: 13/12/2018

PROGRAM REPORT

Program Name: "Seminar on Route map for NABL"

Date of activity: 11/12/2018

Venue: Lecture Hall-III,

Organized by: R&D Cell

Resource person: Dr Anurag Yadav, Assist prof, Department of Biochemistry, Father Muller Medical College Mangalore.

Number of participants: 91 Students & 13 Faculty

Objective of the program

Laboratory accreditation activities are administered under the direction of the National Accreditation Board for Testing and Calibration Laboratories (NABL), involving assessment team and accreditation committee as recommending authorities. NABL is a signatory to Asia Pacific Accreditation Cooperation (APAC) and International Laboratory Accreditation Cooperation (ILAC) through Mutual Recognition Arrangements (MRA). These are based on mutual evaluation and acceptance of other MRA partners. Such international arrangements allow acceptance of test / calibration results between MRA partner countries.

Contents Delivered

The requirements in this document on specific criteria are based on the International Standard, ISO 15189:2012 - "Medical laboratories – Requirements for quality and competence". It specifies requirements for competence and quality that are particular to medical laboratories. The laboratory's compliance to requirements of the standard and its technical competence are assessed by NABL for accreditation. The specific criteria document must be used in conjunction with ISO 15189:2012. It provides an interpretation of the latter document and describes specific requirements. Further, the laboratory shall follow national, regional, local laws and regulations as applicable.

PRINCIPAL
MNR Medical College & Hospital
Fasalwadi, Sangareddy

Chairperson
Internal Quality Assurance Cell (IQAC)
MNR Medical College & Hospital



MNR MEDICAL COLLEGE & HOSPITAL

MNR Nagar, Fasalwadi, Sangareddy - 502 294, Sangareddy Dist. Telangana. India

Ph: + 85000 56667, (08455) 230523, 230527, 230524 Fax No. (08455) - 230555, 230533

Outcome of the program

The participants of the Seminar will be able to understand the knowledge to be eligible for accreditation for disciplines of Histopathology and Cytopathology, a laboratory should receive at least 300 specimens every year in the respective discipline. The latter does not apply to specialized areas viz.: Nephropathology, Neuropathology, where the number of samples received may be fewer. Similarly, in the discipline of Haematology the laboratory should receive at least 100 bone marrow aspiration samples per year for the test to be accredited.

PRINCIPAL
MNR Medical College & Hospital
Fasalwadi, Sangareddy

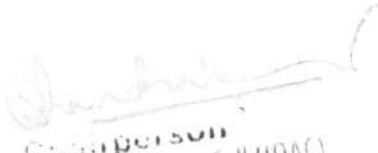

Chairperson
Internal Quality Assurance Cell (IQAC)
MNR Medical College & Hospital



MNR MEDICAL COLLEGE & HOSPITAL

MNR Nagar, Fasalwadi, Sangareddy - 502 294, Sangareddy Dist. Telangana. India

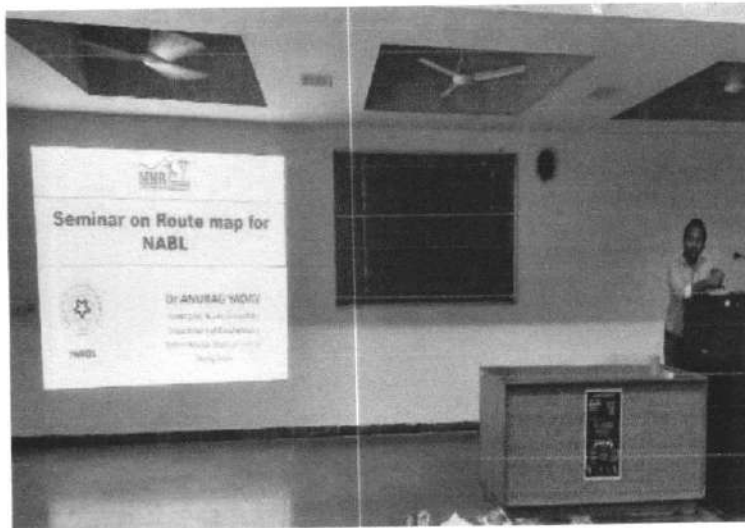
Ph: + 85000 56667, (08455) 230523, 230527, 230524 Fax No. (08455) - 230555, 230533



Program Co-Ordinator

HOD

HOD

PRINCIPAL
MNR MEDICAL COLLEGE & HOSPITAL
FASALWADI, SANGAREDDY-502294

Chairperson
Internal Quality Assurance Cell (IQAC)
MNR Medical College & Hospital

Chairperson
MEDICAL EDUCATION UNIT
MNR Medical College & Hospital



MNR MEDICAL COLLEGE & HOSPITAL

MNR Nagar, Fasalwadi, Sangareddy - 502 294, Sangareddy Dist. Telangana. India

Ph: + 85000 56667, (08455) 230523, 230527, 230524 Fax No. (08455) - 230555, 230533

STUDENT ATTENDANCE SHEET

Program Name: "Seminar on Route map for NABL"

Date of activity: 11/12/2018

S.No	Name of the participant	Course	Signature
1	YASHASREE PASUPULETI	MBBS	<i>Yashasree</i>
2	SOMA NITISH REDDY	MBBS	<i>Nitish Reddy</i>
3	ROSHAN KUMAR M	MBBS	<i>Roshan</i>
4	BANDYALA SAIKUMAR	MBBS	<i>Saij</i>
5	NIKHITA NADIMPALLI	MBBS	<i>Nikhita</i>
6	MUSKU NANDINI	MBBS	<i>Nandini</i>
7	AKULA PALLAVI	MBBS	<i>Pallavi</i>
8	KONGALA RISHITHA	MBBS	<i>Rishitha</i>
9	GOLKONDA KARTHIK	MBBS	<i>Karthik</i>
10	BIRADAR SAIKUMAR	MBBS	<i>Saikumar</i>
11	NAIKOTI RAHUL	MBBS	<i>Rahul</i>
12	KOTHURU SUSHANTH	MBBS	<i>Sushant</i>
13	SEVELLA MANOJ KUMAR	MBBS	<i>Manoj</i>
14	DANDYAR SHIVA PRASAD	MBBS	<i>Prasad</i>
15	BURRA JEEVANA	MBBS	<i>Jeevan</i>
16	MALELA BHANU PRASAD GOUD	MBBS	<i>Bhanu</i>
17	AKKENAPALLY RAJASHEKARACHARY	MBBS	<i>Rajesh</i>
18	JANGITI MANEESHA	MBBS	<i>Mani</i>
19	BOLLOJU GURU PRASAD	MBBS	<i>Guru Prasad</i>
20	P SRILEKHA	MBBS	<i>Srilekha</i>
21	MORAM STOTRA PRIYA	MBBS	<i>Priya</i>

[Signature]
PRINCIPAL
MNR Medical College & Hospital
Fasalwadi, Sanga Reddy

[Signature]
Chairperson
Internal Quality Assurance Cell (IQAC)
MNR Medical College & Hospital



MNR MEDICAL COLLEGE & HOSPITAL

MNR Nagar, Fasalwadi, Sangareddy - 502 294, Sangareddy Dist. Telangana. India

Ph: + 85000 56667, (08455) 230523, 230527, 230524 Fax No. (08455) - 230555, 230533

22	RACHANA RAPOLU	MBBS	Rachana
23	M MANISHA GOUD	MBBS	Manish
24	OGGU SRIKANTH	MBBS	Srikanth
25	EDIGA SAI CHANDANA	MBBS	Chandana
26	MARUGONDA SAKETH VARMA	MBBS	Saketh
27	ANUMALLA MANASWINI	MBBS	Manaswini
28	BANDI NAVEEN KUMAR	MBBS	Naveen
29	SHAIK HASNAD BABA	MBBS	Hasnab
30	MAHEEN SULTANA	MBBS	Maheen
31	BANOTH VASANTH KUMAR	MBBS	Vasanth
32	B ANJALI NAIK	MBBS	Anjali
33	MALAGARI MANEESHA	MBBS	Maneesha
34	CHINMAYEE DESAI	MBBS	Chinmayee
35	GAJULA SRI HARSHA CHAKRAVARTHY	MBBS	Harsha
36	MALKA HARSHITHA	MBBS	Harshitha
37	MENDI DEEKSHITHA	MBBS	Deekshitha
38	YATHAM SRI HARIKA	MBBS	Harika
39	J AISHWARYA	MBBS	Aishwarya
40	MUTHERAGALLA PRATHYUSHA	MBBS	Prathyusha
41	SEELAM LAXMI PRIYA	MBBS	Laxmi Priya
42	BANDILA V V S TANMAIYEE	MBBS	Tanmaiyye
43	GADDAM SRINIVAS	MBBS	Srinivas
44	SK AJEETH MUSHRAF	MBBS	Ajeeth
45	GAJULA CHANDRA HASA	MBBS	Chandra
46	SALADI SAI VENKATA SOWMYA SARADA	MBBS	Sowmya Sarada
47	SHRUTI BOSE	MBBS	Shruti
48	DODDIPALLI BHANU PRAKASH REDDY	MBBS	Bhanu Prakash Reddy

PRINCIPAL
MNR Medical College & Hospital
Fasalwadi, Sanga Reddy

Chairperson
Internal Quality Assurance Cell (IQAC)
MNR Medical College & Hospital



MNR MEDICAL COLLEGE & HOSPITAL

MNR Nagar, Fasalwadi, Sangareddy - 502 294, Sangareddy Dist. Telangana. India

Ph: + 85000 56667, (08455) 230523, 230527, 230524 Fax No. (08455) - 230555, 230533

49	SABHADU SUSHMITHA	MBBS	Sushmitha
50	PRIYANKA RAJ KUMAWAT	MBBS	Priyanka
51	MUGA RITHIKA	MBBS	Rithika
52	R PRANITH KAMLAY	MBBS	Pranith
53	MARPALIKAR YOGESHWARI CHANDRAKANT	MBBS	Yogeshwari
54	RAJA RAJESWAR REDDY ATTLA	MBBS	Rajeswar
55	NABAMITA CHAKRABORTY	MBBS	Nabamita
56	SHUBAM DILIP SHINDE	MBBS	Shubam
57	BODDAM CHANDRALEKHA	MBBS	Chandralekha
58	ROHIT JAJU	MBBS	Rohit
59	NABA KHANAM	MBBS	Naba
60	JAKAREGARI SOLOMON SUMAHITH SURATHAN	MBBS	Solomon
61	AMBATI SAI KEERTHANA	MBBS	Sai Keerthana
62	DAKSHA LONAVATH	MBBS	Daksha
63	ESLAVATH GANESH KUMAR	MBBS	Esavath
64	PANDHIPATI RAMYAPRIYA	MBBS	Ramyapriya
65	GOLAMARI PRANAY PAUL REDDY	MBBS	Pranay
66	CHETANA MAHARANA	MBBS	Chetana
67	RANOO PRIYAMBADA BISWAL	MBBS	Priyambada
68	KUKUDALA KEERTHI	MBBS	Keerthi
69	HAJIRA NOOREIN	MBBS	Noorein
70	GRUSHA VARMA	MBBS	Grusha
71	DURGAPPAGARI KIRANGOUD	MBBS	Kirango
72	DANUGURI UMA	MBBS	Uma
73	APPADI DIVYA	MBBS	Divya
74	GIDDY RAM VARSHITH REDDY	MBBS	Ram Varshith
75	KOTHAPALLI SAICHANDANA	MBBS	Saichandana
76	POLE MOUNIKA	MBBS	Mounika
77	ADELLI SRIDHAR	MBBS	Sridhar
78	BHUKYA HARSHA	MBBS	Harsha

PRINCIPAL
MNR Medical College & Hospital
Sanga Reddy

Chairperson
Internal Quality Assurance Cell (IQAC)
MNR Medical College & Hospital



MNR MEDICAL COLLEGE & HOSPITAL

MNR Nagar, Fasalwadi, Sangareddy - 502 294, Sangareddy Dist. Telangana. India

Ph: + 85000 56667, (08455) 230523, 230527, 230524 Fax No. (08455) - 230555, 230533

79	PERUMANDLA HANISHA	MBBS	Hanisha
80	GEENUKUNTA AMRUTH KUMAR	MBBS	Amruth Kumar
81	JOGINAPALLY GAYATHRI	MBBS	Gayathri
82	GUNTOJU SUDEEP	MBBS	Sudeep
83	NUTALAPATI MOHAN KRISHNA	MBBS	Mohan Krishna
84	PRANEESHA REDDY KANDI	MBBS	Praneesha
85	RAPAKA SHERLY	MBBS	Sherly
86	SHIVDUTT S KANDI	MBBS	Kandi
87	KADIYALA LIKHITHAA	MBBS	Likhitha
88	YEDIVALLY PRASHANTH REDDY	MBBS	Prashanth Reddy
89	NITIN SHARMA	MBBS	Nitin
90	SAGGIDI NIKITHA	MBBS	Nikitha
91	PR RAJA RAMA CHANDRA REDDY	MBBS	Chandra

Program Co-Ordinator

HOD

PRINCIPAL
MNR Medical College & Hospital
Fasalwadi, Sangareddy

Chairperson
Internal Quality Assurance Cell (IQAC)
MNR Medical College & Hospital



MNR MEDICAL COLLEGE & HOSPITAL

MNR Nagar, Fasalwadi, Sangareddy - 502 294, Sangareddy Dist. Telangana. India

Ph: + 85000 56667, (08455) 230523, 230527, 230524 Fax No. (08455) - 230555, 230533

FACULTY ATTENDANCE SHEET

Program Name: "Seminar on Route map for NABL"

Date of activity: 11/12/2018

S.No	Name of the Faculty	Department	Signature
1	Dr. Bhavani	OBGY	Bhavani
2	Dr. Sindhu	Genl surg	[Signature]
3	Dr. N. Deepika	ophthal	[Signature]
4	Dr. Balu Rao	ophthal	[Signature]
5	Dr. Indira	Genl medicine	[Signature]
6	Dr. Pavan K	Prochem	[Signature]
7	Dr. Vipula	Microbiology	[Signature]
8	Dr. Ilain	Genl Surg	[Signature]
9	Dr. Nagababu	Prochem	Nagababu
10	Dr. Anandha Rajan	Genl Surg	[Signature]
11	Dr. Chandrasekar S	Pathology	[Signature]
12	Dr. P. Suresh	microbiology	P. Suresh
13	Dr. Sumithra	Anatomy	[Signature]

Program Co-Ordinator

HOD

PRINCIPAL
MNR Medical College & Hospital
Fasalwadi, Sanga Reddy

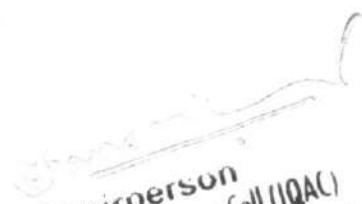
Chairperson
Internal Quality Assurance Cell (IQAC)
MNR Medical College & Hospital



MNR Medical College

Fasalwadi, Sangareddy, Hyderabad, Telangana-502 294.

Certificate of Participation

This is to certify that

YASHASREE PASUPULETI

has participated in A Seminar on

“Route Map for NABL”

on 11/12/2018 organised by R&D Cell, conducted at MNR Medical College,
Fasalwadi, Sangareddy, Hyderabad, Telangana-502 294.

Convener

Principal

MNR MEDICAL COLLEGE & HOSPITAL
FASALWADI, SANGAREDDY-502294

Chairperson

Internal Quality Assurance Cell (IQAC)
MNR Medical College & Hospital



MNR Medical College

Fasalwadi, Sangareddy, Hyderabad, Telangana-502 294.

Certificate of Participation

This is to certify that

_____ SOMA NITHISA REDDY

has participated in A Seminar on

“Route Map for NABL”

on 11/12/2018 organised by R&D Cell, conducted at MNR Medical College,
Fasalwadi, Sangareddy, Hyderabad, Telangana-502 294.

_____ 
Convener

_____ 
Principal

PRINCIPAL

MNR MEDICAL COLLEGE & HOSPITAL
FASALWADI, SANGAREDDY-502294

Chairperson

Internal Quality Assurance Cell (IQAC)
MNR Medical College & Hospital



MNR Medical College

Fasalwadi, Sangareddy, Hyderabad, Telangana-502 294.

Certificate of Participation

This is to certify that

ROSHAN KUMAR M

has participated in A Seminar on

“Route Map for NABL”

on 11/12/2018 organised by R&D Cell, conducted at MNR Medical College,
Fasalwadi, Sangareddy, Hyderabad, Telangana-502 294.

Convener

Principal

PRINCIPAL

MNR MEDICAL COLLEGE & HOSPITAL
FASALWADI, SANGAREDDY-502294

Chairperson

Internal Quality Assurance Cell (IQAC)
MNR Medical College & Hospital



MNR Medical College

Fasalwadi, Sangareddy, Hyderabad, Telangana-502 294.

Certificate of Participation

This is to certify that

NIKITHA NADIMBALLI

has participated in A Seminar on

“Route Map for NABL”

on 11/12/2018 organised by R&D Cell, conducted at MNR Medical College,
Fasalwadi, Sangareddy, Hyderabad, Telangana-502 294.

Convener

Principal

PRINCIPAL

MNR MEDICAL COLLEGE & HOSPITAL
FASALWADI, SANGAREDDY-502294

Chairperson

Internal Quality Assurance Cell (IQAC)
MNR Medical College & Hospital



MNR Medical College

Fasalwadi, Sangareddy, Hyderabad, Telangana-502 294.

Certificate of Participation

This is to certify that

MUSKU NANDINI

has participated in A Seminar on

“Route Map for NABL”

on 11/12/2018 organised by R&D Cell, conducted at MNR Medical College,
Fasalwadi, Sangareddy, Hyderabad, Telangana-502 294.

Convener

Principal

PRINCIPAL

MNR MEDICAL COLLEGE & HOSPITAL
FASALWADI, SANGAREDDY-502294

Chairperson
Internal Quality Assurance Cell (IQAC)
MNR Medical College & Hospital



MNR Medical College

Fasalwadi, Sangareddy, Hyderabad, Telangana-502 294.

Certificate of Participation

This is to certify that

Dr. LINGARAT LATURE

has participated in A Seminar on

“Route Map for NABL”

on 11/12/2018 organised by R&D Cell, conducted at MNR Medical College,
Fasalwadi, Sangareddy, Hyderabad, Telangana-502 294.

Convener

Principal

PRINCIPAL

MNR MEDICAL COLLEGE & HOSPITAL
FASALWADI, SANGAREDDY-502294

Chairperson

Internal Quality Assurance Cell (IQAC)
MNR Medical College & Hospital