



MNR MEDICAL COLLEGE & HOSPITAL

MNR Nagar, Fasalwadi, Sangareddy - 502 294, Sangareddy Dist. Telangana. India

Ph: + 85000 56667, (08455) 230523, 230527, 230524 Fax No. (08455) - 230555, 230533

CIRCULAR

Date: 21-09-2020

All the staff members and students are invited for a seminar titled "Good Pharmacy practice -ADR" to be conducted by the ED Cell on 29th September 2020. The venue of the presentation is Biochemistry Demo Hall 2. Please take this opportunity to enlighten yourself and enhance your career.



Principal

PRINCIPAL
MNR Medical College & Hospital
Fasalwadi, Sangareddy

Copy to

- Medical Superintendent
- CEO
- Assistant Director
- Chief Academic Officer
- IQAC
- Concerned HODs
- Notice Boards

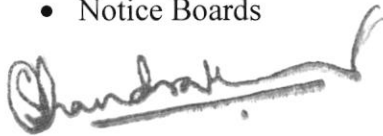

Chairperson
Internal Quality Assurance Cell (IQAC)
MNR Medical College & Hospital



MNR MEDICAL COLLEGE & HOSPITAL

MNR Nagar, Fasalwadi, Sangareddy - 502 294, Sangareddy Dist. Telangana. India

Ph: + 85000 56667, (08455) 230523, 230527, 230524 Fax No. (08455) - 230555, 230533

Date: 02/10/2020

PROGRAM REPORT

Program Name: "Good Pharmacy practice –ADR"

Date of activity: 29/09/2020

Venue: Biochemistry Demo Hall 2

Organized by: ED Cell

Resource person: Dr Madhukar Rao P, Assistant professor, Department of Pharmacology,
MNR Medical College & Hospital, Sangareddy

Number of participants: 87 Students & 11 Faculty

Objective of the program

The main objective of the seminar is to make everyone aware of ADR such that Hospital-based ADR monitoring and reporting programmes aim to identify and quantify the risks associated with the use of drugs provided in a hospital setting.

Contents Delivered

- Definition and Classification of ADR
- Detection, Report writing of ADR
- Causality Assessment and Prevention

Outcome of the program

The seminar concentrated on the good pharmacology practice by reporting the adverse drug reaction among patients. The seminar concentrated on spreading awareness of importance of reporting the adverse reactions and also the use of such pharmacovigilance for betterment of patient care in hospital. The seminar ended with happy note and take home message of how important is reporting adverse drug reactions among patients.



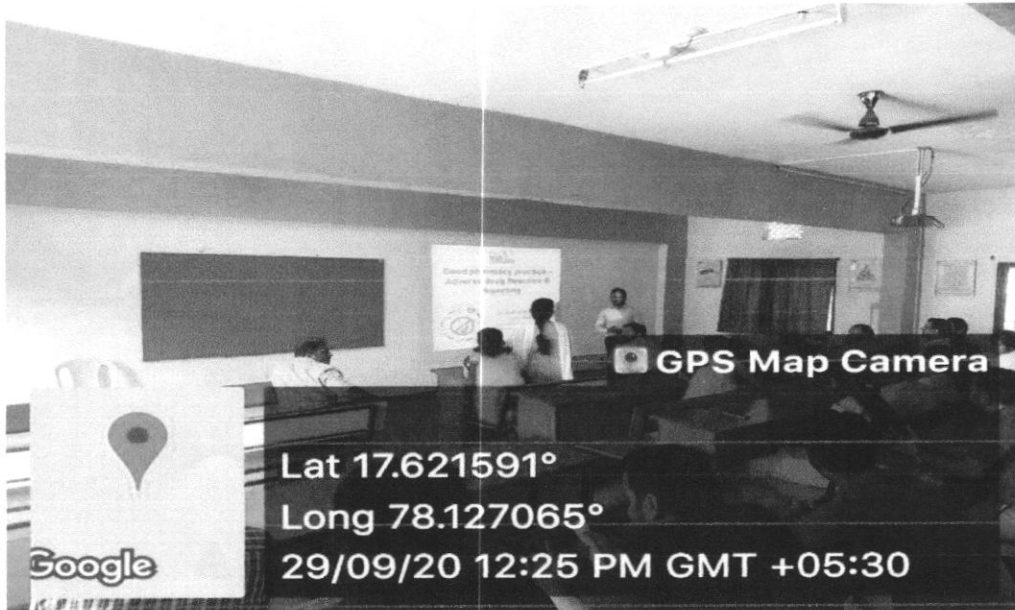

Lat 17.621591°
Long 78.127065°
29/09/20 12:25 PM GMT +05:30

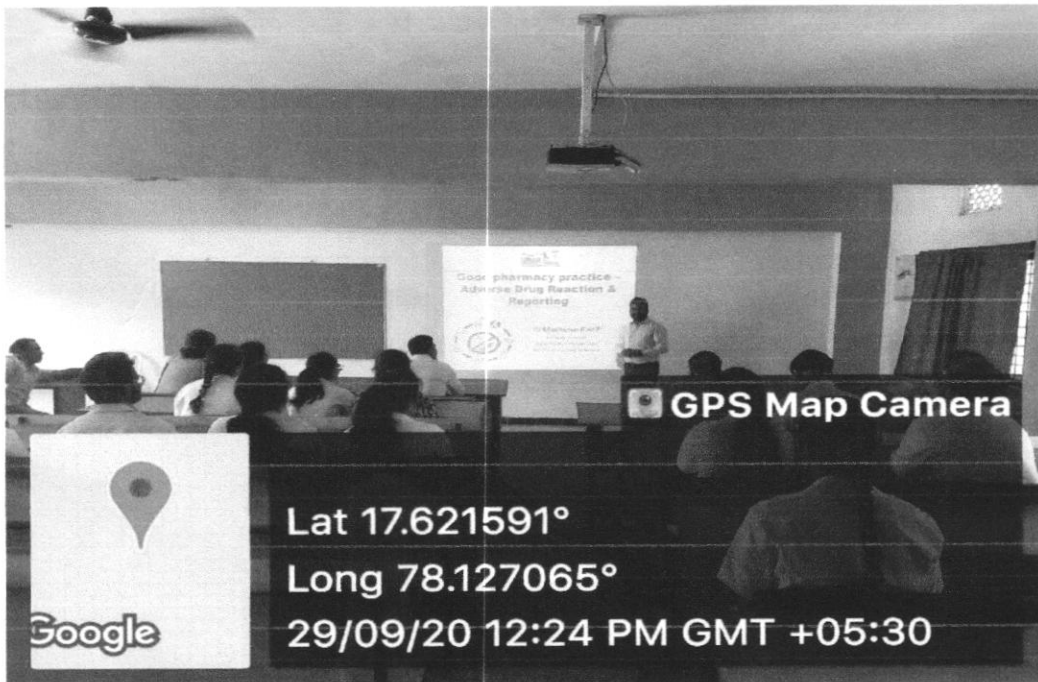

Lat 17.621591°
Long 78.127065°
29/09/20 12:24 PM GMT +05:30

Program Co-Ordinator
HOD

Internal Quality Assurance Cell (IQAC)
MNR Medical College & Hospital

Chairperson
MEDICAL EDUCATION UNIT
MNR Medical College & Hospital



MNR MEDICAL COLLEGE & HOSPITAL

MNR Nagar, Fasalwadi, Sangareddy - 502 294, Sangareddy Dist. Telangana. India

Ph: + 85000 56667, (08455) 230523, 230527, 230524 Fax No. (08455) - 230555, 230533

Program Name: "Good Pharmacy practice -ADR"

Date of activity: 29/09/2020

S.No	Name of the participant	Course	Signature
1	HUMERA FATIMA	MBBS	FATIMA
2	USHASREE KONDAM	MBBS	Usha
3	KATTA NAVYA JAYA LAKSHMI	MBBS	Navya jaya
4	P SRAVYA	MBBS	Sravya
5	KANKANTI NEETHA REDDY	MBBS	NEETHA
6	BODA CHRISTINA	MBBS	christina
7	RAGAM SHALINI YADAV	MBBS	SHALINI
8	MANISHA CHALLURI	MBBS	Manisha
9	MALLE SIMEON	MBBS	SIMEON
10	TADIBOYINA KAVYA	MBBS	Kavya
11	AVVARU CHANDANA	MBBS	Chandana
12	LAUDIA TEJASVEE	MBBS	Tejasvee
13	R LAXMAN	MBBS	Laxman
14	KALIDINDI SONY SANTOSH VARMA	MBBS	Santosh
15	REMALLA APARAJITHA	MBBS	Aparajitha
16	KURRE SPANDANAREDDY	MBBS	Spandanareddy
17	VEJELLA SWETHA DEVI	MBBS	Swetha
18	KAVALI SUPRIYA	MBBS	Supriya
19	NOOREEN FATIMA	MBBS	Fatima
20	MAGULURI SUNIDHI	MBBS	Sunidhi
21	BOYAPALLY KIRANMAI	MBBS	Kiranmai
22	TANAKAM YASHWANTHI	MBBS	Yashwanthi
23	K.RAMYA	MBBS	Ramya
24	DHANCHETTI KAVERI	MBBS	Kaveri

PRINCIPAL
MNR Medical College & Hospital
Fasalwadi, Sangareddy

Internal Quality Assurance Cell (IQAC)
MNR Medical College & Hospital



MNR MEDICAL COLLEGE & HOSPITAL

MNR Nagar, Fasalwadi, Sangareddy - 502 294, Sangareddy Dist. Telangana. India

Ph: + 85000 56667, (08455) 230523, 230527, 230524 Fax No. (08455) - 230555, 230533

25	CHOUTIPPELly AKHILESH	MBBS	Akhilesh
26	DASARI SUDESHNA	MBBS	Sudeshna
27	SALADI SRI RAJESWARI	MBBS	Rajeswari
28	ADITI ASTHANA	MBBS	Asthana
29	KONKATHI SHRUTHI	MBBS	Shruthi
30	DEVANSH PARLAWAR	MBBS	Devansh
31	DBAHNBHAR PRAJWAL VINOD	MBBS	Vinod
32	SANNIDHYA SHARMA	MBBS	Sannidhya
33	RAUT AKASH DATTATRAY	MBBS	Raut
34	MUKUL SANER	MBBS	Mukul
35	M.SOUMYA SREE	MBBS	Soumya
36	UTTEKAR RUSHIKESH DIPAK	MBBS	Dipak
37	SETTI SRI PRABHAS	MBBS	Prabhas
38	KHEDKAR POONAM BHUJANGRAO	MBBS	Poonam
39	ZERIKUNTHE SHIVANI	MBBS	Shivani
40	SPURTHI CHOUTAKURI	MBBS	Spurthi
41	DAMERACHERLA SAI HARSHA	MBBS	Harsha
42	DHAWALE AMAN SURESH	MBBS	Aman
43	MEKALA SNEHA SREE	MBBS	Sneha
44	M.PRIYANKA	MBBS	Priyanka
45	RISHAM MUHAMMED	MBBS	Risham
46	SHUBHAM SINGH	MBBS	Shubham
47	MEDIWAR SHRUTI SHRIKANT	MBBS	Shruti
48	AITHA SRIVARSHA	MBBS	SriVarsha
49	ARIHANT BISWAJIT DAS	MBBS	Arihant
50	VELDANDA SAI SAHITHI	MBBS	Sahithi
51	ALLADI R ABHIGNA	MBBS	Abhigna
52	MAJETY DEVIKA	MBBS	Devika
53	KONDA UDAY KUMAR	MBBS	Uday
54	S.MAAYYA	MBBS	Maayya

PRINCIPAL
MNR Medical College & Hospital
Fasalwadi, Sanga Reddy

Chairperson
Internal Quality Assurance Cell (IQAC)
MNR Medical College & Hospital

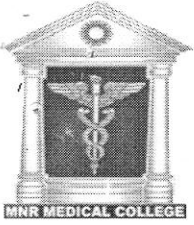

MNR MEDICAL COLLEGE & HOSPITAL

MNR Nagar, Fasalwadi, Sangareddy - 502 294, Sangareddy Dist. Telangana. India

Ph: + 85000 56667, (08455) 230523, 230527, 230524 Fax No. (08455) - 230555, 230533

55	AYYANKI SANJANA	MBBS	Sanjana
56	RAHATHUNNISA	MBBS	Raha
57	MEDISETTI LAKSHMI BRAMITHA	MBBS	Lakshmi
58	JAYA SINDHURI V	MBBS	Jaya
59	AHMED BIN MUKHTADER JABRI	MBBS	Mukhtar
60	VAJAGOUNI NIKHIL GOUD	MBBS	Nikhil
61	MEGHNA REDDY GUMI REDDY	MBBS	Meghna
62	AMTULLAH HADIYA	MBBS	Amtullah
63	SRILEKHYA BANDARUPALLI	MBBS	Srilekha
64	MUTTAVARAPU RAJYA LAKSHMI	MBBS	Rajya Lakshmi
65	TAMMEWAR GURURAJ SANTOSHRAO	MBBS	Santoshrao
66	TIRUMALASETTI S L BHAVANA	MBBS	Bhavana
67	SRAVANTHI ALLADA	MBBS	Sravanthi
68	T N MADHURI	MBBS	Madhuri
69	JILLELA VENKATESWARA REDDY	MBBS	Venkateshwar
70	PUPPALA SANJANA	MBBS	Sanjana
71	VINEESHA YADAV A	MBBS	Vineesha
72	D PRIYA	MBBS	Priya
73	YASHASREE PASUPULETI	MBBS	Yashasree
74	SOMA NITISH REDDY	MBBS	Nitish
75	ROSHAN KUMAR M	MBBS	Roshan
76	BANDYALA SAIKUMAR	MBBS	Sai
77	NIKHITA NADIMPALLI	MBBS	Nikhita
78	MUSKU NANDINI	MBBS	Nandini
79	AKULA PALLAVI	MBBS	Pallavi
80	KONGALA RISHITHA	MBBS	Rishitha
81	GOLKONDA KARTHIK	MBBS	Karthik
82	BIRADAR SAIKUMAR	MBBS	Saikumar
83	NAIKOTI RAHUL	MBBS	Rahul
84	KOTHURU SUSHANTH	MBBS	Sushanth
85	SEVELLA MANOJ KUMAR	MBBS	Manoj
86	DANDYAR SHIVA PRASAD	MBBS	Shiva
87	BURRA JEEVANA	MBBS	Jeevana

PRINCIPAL
MNR Medical College & Hospital
Fasalwadi, Sangareddy

Chairman
Internal Quality Assurance
MNR Medical College & Hospital



MNR MEDICAL COLLEGE & HOSPITAL

MNR Nagar, Fasalwadi, Sangareddy - 502 294, Sangareddy Dist. Telangana. India

Ph: + 85000 56667, (08455) 230523, 230527, 230524 Fax No. (08455) - 230555, 230533

FACULTY ATTENDANCE SHEET

Program Name: "Good Pharmacy practice -ADR"

Date of activity: 29/09/2020

S.No	Name of the Faculty	Department	Signature
1	Dr. Pushpakumari	Gen med	
2	Dr. Nagababu	Biochemistry	
3	Dr. Bhavani	OBGY	
4	Dr. Bahuram	Gen surgery	
5	Dr. Sateenivas	Gen surg	
6	Dr. P. Suresh	microbiology	
7	Dr. Ilaiyatharam	Gen. Surgery	
8	Dr. Rakesh Dixit	Gen med	
9	Dr. Ananda Prasad	Gen surgery	
10	Dr. Sunitha	Anatomy	
11	Dr. Karthik	Gen. Surgery	

Program Co-Ordinator
HOD

Chairperson
Internal Quality Assurance Cell (IQAC)
MNR Medical College & Hospital

PRINCIPAL
MNR Medical College & Hospital
Fasalwadi, Sanga Reddy



MNR Medical College

Fasalwadi, Sangareddy, Hyderabad, Telangana-502 294.

CERTIFICATE OF PARTICIPATION

THIS IS TO CERTIFY THAT

Ayyappa Sanyal

HAS PARTICIPATED IN A WORKSHOP ON

“Good Pharmacy practice –ADR”

ON 29/09/2020 ORGANISED BY ED CELL, CONDUCTED AT MNR MEDICAL COLLEGE,

FASALWADI, SANGAREDDY, HYDERABAD, TELANGANA-502 294.

Chairperson
Internal Quality Assurance Cell (IQAC)
MNR Medical College & Hospital

Principal
MNR MEDICAL COLLEGE
FASALWADI, SANGAREDDY-502294



MNR Medical College

Fasalwadi, Sangareddy, Hyderabad, Telangana-502 294.

CERTIFICATE OF PARTICIPATION

THIS IS TO CERTIFY THAT

_____ godkonda kashika _____

HAS PARTICIPATED IN A WORKSHOP ON

“Good Pharmacy practice –ADR”

ON 29/09/2020 ORGANISED BY ED CELL, CONDUCTED AT MNR MEDICAL COLLEGE,

FASALWADI, SANGAREDDY, HYDERABAD, TELANGANA-502 294.

[Signature]
Chairperson
Internal Quality Assurance Cell (IQAC)
MNR Medical College & Hospital

[Signature]
Principal
MNR MEDICAL COLLEGE
FASALWADI, SANGAREDDY-502294

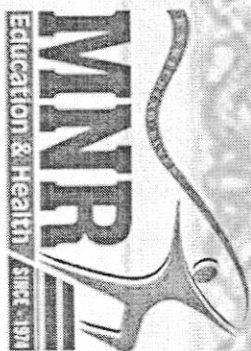

MNR Medical College

Fasalwadi, Sangareddy, Hyderabad, Telangana-502 294.

CERTIFICATE OF PARTICIPATION

THIS IS TO CERTIFY THAT

Shashi Medhewar

HAS PARTICIPATED IN A WORKSHOP ON

“Good Pharmacy practice –ADR”

ON 29/09/2020 ORGANISED BY ED CELL, CONDUCTED AT MNR MEDICAL COLLEGE,

FASALWADI, SANGAREDDY, HYDERABAD, TELANGANA-502 294.

[Signature]
Chairperson
Internal Quality Assurance Cell (IQAC)
MNR Medical College & Hospital

[Signature]
Principal
MNR MEDICAL COLLEGE
FASALWADI, SANGAREDDY-502294



MNR Medical College

Fasalwadi, Sangareddy, Hyderabad, Telangana-502 294.

CERTIFICATE OF PARTICIPATION

THIS IS TO CERTIFY THAT

_____ *Dr. Sumanthini*

HAS PARTICIPATED IN A WORKSHOP ON

“Good Pharmacy practice –ADR”

ON 29/09/2020 ORGANISED BY ED CELL, CONDUCTED AT MNR MEDICAL COLLEGE,

FASALWADI, SANGAREDDY, HYDERABAD, TELANGANA-502 294.

[Signature]
Chairperson
Internal Quality Assurance Cell (IQAC)
MNR Medical College & Hospital

[Signature]
Principal
MNR MEDICAL COLLEGE
FASALWADI, SANGAREDDY-502294



MNR Medical College

Fasalwadi, Sangareddy, Hyderabad, Telangana-502 294.

CERTIFICATE OF PARTICIPATION

THIS IS TO CERTIFY THAT

Dr. Deepika.

HAS PARTICIPATED IN A WORKSHOP ON

“Good Pharmacy practice –ADR”

ON 29/09/2020 ORGANISED BY ED CELL, CONDUCTED AT MNR MEDICAL COLLEGE,

FASALWADI, SANGAREDDY, HYDERABAD, TELANGANA-502 294.

Chairperson
Internal Quality Assurance Cell (IQAC),
MNR Medical College & Hospital

Principal
MNR MEDICAL COLLEGE,
FASALWADI, SANGAREDDY-502294

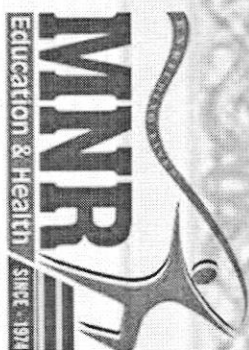

MNR Medical College

Fasalwadi, Sangareddy, Hyderabad, Telangana-502 294.

CERTIFICATE OF PARTICIPATION

THIS IS TO CERTIFY THAT

_____ Dr. Harsha Yadav.

HAS PARTICIPATED IN A WORKSHOP ON

“Good Pharmacy practice –ADR”

ON 29/09/2020 ORGANISED BY ED CELL, CONDUCTED AT MNR MEDICAL COLLEGE,

FASALWADI, SANGAREDDY, HYDERABAD, TELANGANA-502 294.

Chairperson
Internal Quality Assurance Cell (IQAC),
MNR Medical College & Hospital

Principal
MNR MEDICAL COLLEGE,
FASALWADI, SANGAREDDY-502294

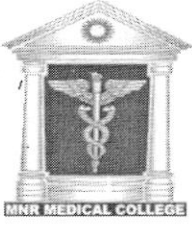

MNR MEDICAL COLLEGE & HOSPITAL

MNR Nagar, Fasalwadi, Sangareddy - 502 294, Sangareddy Dist. Telangana. India

Ph: + 85000 56667, (08455) 230523, 230527, 230524 Fax No. (08455) - 230555, 230533

CIRCULAR

Date: 29-09-2020

All the staff members and students are invited for a seminar titled "Good Clinical Practice – Biomedical Waste Management" to be conducted by the ED Cell on 06th October 2020. The venue of the presentation is Biochemistry Demo Hall 2. Please take this opportunity to enlighten yourself and enhance your career.

Principal

Copy to

- Medical Superintendent
- CEO
- Assistant Director
- Chief Academic Officer
- IQAC
- Concerned HODs
- Notice Boards

Chairperson
Internal Quality Assurance Cell (IQAC)
MNR Medical College & Hospital

PRINCIPAL
MNR Medical College & Hospital
Fasalwadi, Sanga Reddy



MNR MEDICAL COLLEGE & HOSPITAL

MNR Nagar, Fasalwadi, Sangareddy - 502 294, Sangareddy Dist. Telangana. India

Ph: + 85000 56667, (08455) 230523, 230527, 230524 Fax No. (08455) - 230555, 230533

Date: 10/10/2020

PROGRAM REPORT

Program Name: "Good Clinical Practice – Biomedical Waste Management"

Date of activity: 06/10/2020

Venue: Biochemistry Demo Hall 2

Organized by: ED Cell

Resource person: Dr Vipula, Associate professor, Department of Microbiology, MNR
Medical College & Hospital, Sangareddy

Number of participants: 91 Students & 12 Faculty

Objective of the program

The main objective of the seminar is to make everyone aware and protect our environment from pollution and contamination and repair and reduce the damage caused by pollution. Irresponsibly disposed of waste can lead to various diseases and can harm people.

Contents Delivered

- Separation (segregation)
- Identification (different color-coded bags)
- Handling (collection, measurement, storage, transport)
- Treatment (off-site and on-site)
- Waste reduction (by shredding)
- Disposal.

Outcome of the program

The seminar concentrated on the good clinical practice by learning basics of how to handle the biomedical waste and how the biomedical waste should be managed. The seminar also put view on how a good biomedical waste management will help to avoid the risk of contamination and also self risk from such hazardous waste material generated in hospital.

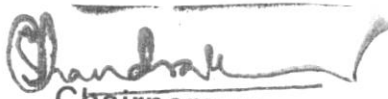
Chairperson
Internal Quality Assurance Cell (IQAC)
MNR Medical College & Hospital

PRINCIPAL
MNR Medical College & Hospital
Fasalwadi, Sanga Reddy

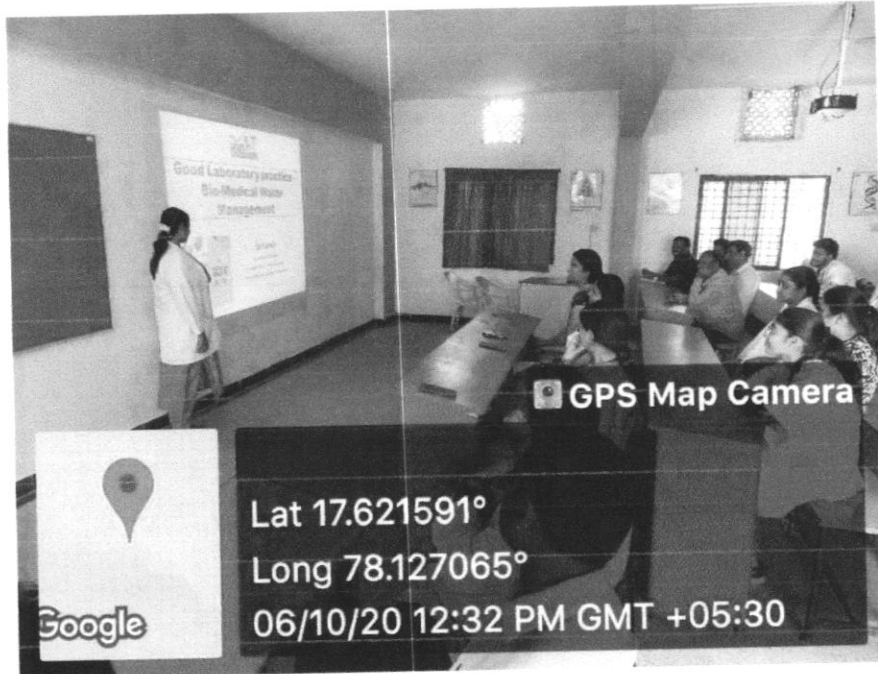
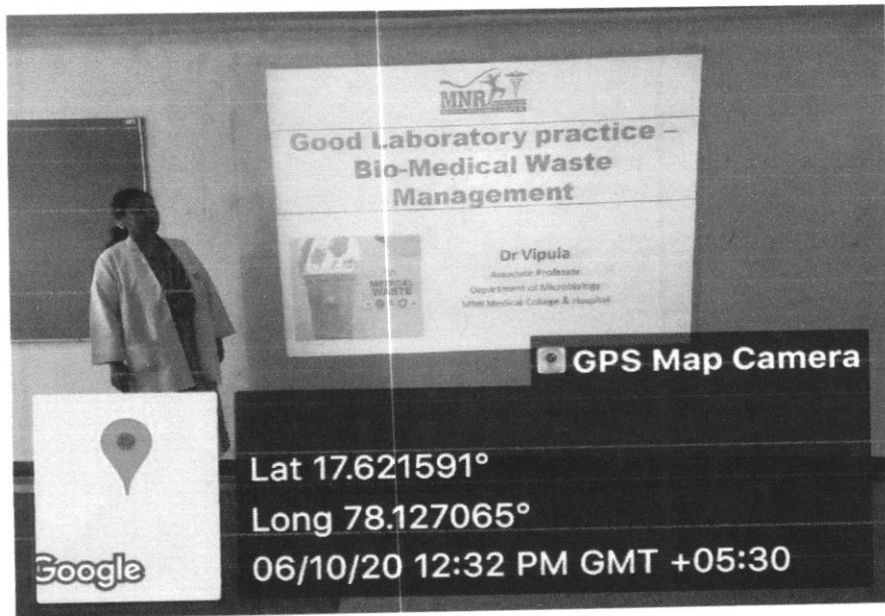

Chandrasekhar

Chairperson
Internal Quality Assurance Cell (IQAC)
MNR Medical College & Hospital

MM

Chairperson
MEDICAL EDUCATION UNIT
MNR Medical College & Hospital



MNR MEDICAL COLLEGE & HOSPITAL

MNR Nagar, Fasalwadi, Sangareddy - 502 294, Sangareddy Dist. Telangana. India

Ph: + 85000 56667, (08455) 230523, 230527, 230524 Fax No. (08455) - 230555, 230533

Date of activity: 06/10/2020

S.No	Name of the participant	Course	Signature
1	PATLOLLA BHOOPAL REDDY	MBBS	BHOOPAL
2	MEDI ANUP RAO	MBBS	Anup.
3	NUKALA NIHITHA	MBBS	N. Hitha
4	YASHASREE PASUPULETI	MBBS	Yashashree
5	SOMA NITISH REDDY	MBBS	NITISH
6	ROSHAN KUMAR M	MBBS	Roshan
7	BANDYALA SAIKUMAR	MBBS	Sai Kumar
8	NIKHITA NADIMPALLI	MBBS.	Nikhita
9	MUSKU NANDINI	MBBS	Nandini
10	AKULA PALLAVI	MBBS	Pallavi
11	KONGALA RISHITHA	MBBS	Rishitha
12	GOLKONDA KARTHIK	MBBS	Karthik.
13	BIRADAR SAIKUMAR	MBBS	Saikumar
14	NAIKOTI RAHUL	MBBS	Rahul.
15	KOTHURU SUSHANTH	MBBS	Sushanth
16	SEVELLA MANOJ KUMAR	MBBS	Manoj
17	DANDYAR SHIVA PRASAD	MBBS	Shiva
18	BURRA JEEVANA	MBBS	Jeevana
19	MALELA BHANU PRASAD GOUD	MBBS	Bhanu
20	AKKENAPALLY RAJASHEKARACHARY	MBBS	Rajashakarachary
21	JANGITI MANEESHA	MBBS	Maneesha
22	BOLLOJU GURU PRASAD	MBBS.	Guru
23	P SRILEKHA	MBBS	Srilekha
24	MORAM STOTRA PRIYA	MBBS.	Priya
25	RACHANA RAPOLU	MBBS	Rachana

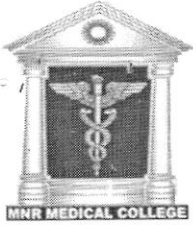

MNR MEDICAL COLLEGE & HOSPITAL

MNR Nagar, Fasalwadi, Sangareddy - 502 294, Sangareddy Dist. Telangana. India

Ph: + 85000 56667, (08455) 230523, 230527, 230524 Fax No. (08455) - 230555, 230533

26	M MANISHA GOUD	MBBS	Manisha
27	OGGU SRIKANTH	MBBS	Srikanth
28	EDIGA SAI CHANDANA	MBBS	Chandana
29	MARUGONDA SAKETH VARMA	MBBS	Saketh
30	ANUMALLA MANASWINI	MBBS	Manaswini
31	BANDI NAVEEN KUMAR	MBBS	Naveen Kumar
32	SHAIK HASNAD BABA	MBBS	Hasnada
33	MAHEEN SULTANA	MBBS	Suhana
34	BANOTH VASANTH KUMAR	Vasanth MBBS	Vasanth
35	B ANJALI NAIK	MBBS	Anjali
36	MALAGARI MANEESHA	MBBS	Maneesha
37	CHINMAYEE DESAI	MBBS	Chinmayee
38	GAJULA SRI HARSHA CHAKRAVARTHY	MBBS	Harsha
39	MALKA HARSHITHA	MBBS	Harshitha
40	MENDI DEEKSHITHA	MBBS	Deekshitha
41	YATHAM SRI HARIKA	MBBS	Harika
42	J AISHWARYA	MBBS	Aishwarya
43	MUTHERAGALLA PRATHYUSHA	MBBS	Prathyusha
44	SEELAM LAXMI PRIYA	MBBS	Laxmi
45	BANDILA V V S TANMAIYEE	MBBS	Tanmayee
46	GADDAM SRINIVAS	MBBS	Srinivas
47	SK AJEETH MUSHRAF	MBBS	SK. AJEETH MUSHRAF
48	GAJULA CHANDRA HASA	MBBS	Chandana
49	SALADI SAI VENKATA SOWMYA SARADA	MBBS	Sowmya
50	SHRUTI BOSE	MBBS	Shruti
51	DODDIPALLI BHANU PRAKASH REDDY	MBBS	Bhanu
52	SABHADU SUSHMITHA	MBBS	Sushmitha
53	PRIYANKA RAJ KUMAWAT	MBBS	Priyanka
54	MUGA RITHIKA	MBBS	Rithika
55	R PRANITH KAMLAY	MBBS	Pranith

PRINCIPAL

MNR Medical College & Hospital
Fasalwadi, Sangareddy,

Chairperson
Internal Quality Assurance Cell (IQAC)
MNR Medical College & Hospital



MNR MEDICAL COLLEGE & HOSPITAL

MNR Nagar, Fasalwadi, Sangareddy - 502 294, Sangareddy Dist. Telangana. India

Ph: + 85000 56667, (08455) 230523, 230527, 230524 Fax No. (08455) - 230555, 230533

56	MARPALIKAR YOGESHWARI CHANDRAKANT	MBBS	Yogeshwari Chandrakant
57	RAJA RAJESWAR REDDY ATTLA	MBBS	Raja
58	NABAMITA CHAKRABORTY	MBBS	Nabamita
59	SHUBAM DILIP SHINDE	MBBS	Dilip
60	BODDAM CHANDRALEKHA	MBBS	Chandralekha
61	ROHIT JAJU	MBBS	Rohit
62	NABA KHANAM	MBBS	Naba Khanam
63	JAKAREGARI SOLOMON SUMAHITH SURATHAN	MBBS	Solahith
64	AMBATI SAI KEERTHANA	MBBS	Sai Keerthana
65	DAKSHA LONAVATH	MBBS	Lonavath
66	ESLAVATH GANESH KUMAR	MBBS	Ganesh
67	PANDHIPATI RAMYAPRIYA	MBBS	Ramyapriya
68	GOLAMARI PRANAY PAUL REDDY	MBBS	Pranay
69	CHELANA MAHARANA	MBBS	Chelana
70	RANOO PRIYAMBADA BISWAL	MBBS	Priyambada
71	KUKUDALA KEERTHI	MBBS	Keerthi
72	HAJIRA NOOREIN	MBBS	Noorein
73	GRUSHA VARMA	MBBS	Grusha
74	DURGAPPAGARI KIRANGOUD	MBBS	Kirangoth
75	DANUGURI UMA	MBBS	Uma
76	APPADI DIVYA	MBBS	Divya
77	GIDDY RAM VARSHITH REDDY	MBBS	Varshith
78	KOTHAPALLI SAICHANDANA	MBBS	Sai Chandana
79	POLE MOUNIKA	MBBS	Mounika
80	ADELLI SRIDHAR	MBBS	Sridhar
81	BHUKYA HARSHA	MBBS	Harsha
82	PERUMANDLA HANISHA	MBBS	Hanisha
83	GEENUKUNTA AMRUTH KUMAR	MBBS	Amruth
84	JOGINAPALLY GAYATHRI	MBBS	Gayathri
85	GUNTOJU SUDEEP	MBBS	Sudeep
86	NUTALAPATI MOHAN KRISHNA	MBBS	Mohan Krishna
87	PRANEESHA REDDY KANDI	MBBS	Praneesha Reddy Kandi

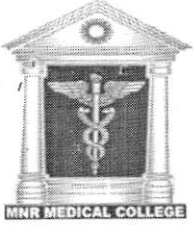

MNR MEDICAL COLLEGE & HOSPITAL

MNR Nagar, Fasalwadi, Sangareddy - 502 294, Sangareddy Dist. Telangana. India

Ph: + 85000 56667, (08455) 230523, 230527, 230524 Fax No. (08455) - 230555, 230533

88	RAPAKA SHERLY	MBBS	Sherly
89	SHIVDUTT S KANDI	MBBS	Shivdutt
90	KADIYALA LIKHITHAA	MBBS	Likhithaa
91	YEDIVALLY PRASHANTH REDDY	MBBS	Prashanth

Program Co-Ordinator
HOD

FACULTY ATTENDANCE SHEET

Program Name: "Good Clinical Practice – Biomedical Waste Management"

Date of activity: 0/10/2020

S.No	Name of the Faculty	Department	Signature
1	Dr. S. Steenivas	Gen Surg	S. Steenivas
2	Dr. Anandha Prasad	Gen Surg	Anandha Prasad
3	Dr. Pushpakumari	Gen med	Pushpakumari
4	Dr. Sindhu	Gen med	Sindhu

PRINCIPAL
MNR Medical College & Hospital
Fasalwadi, Sangareddy

Chairperson
Internal Quality Assurance Cell (IQAC)
MNR Medical College & Hospital



MNR MEDICAL COLLEGE & HOSPITAL

MNR Nagar, Fasalwadi, Sangareddy - 502 294, Sangareddy Dist. Telangana. India

Ph: + 85000 56667, (08455) 230523, 230527, 230524 Fax No. (08455) - 230555, 230533

5	Dr. Ilaiyah. Yadav.	Gen surg	Ilaiyah
6	Dr. Rakesh dhist	Gen med	Rakesh
7	Dr. Bhavani	OBGYN	Bhavani
8	Dr. P. Suresh	microbiology	P. Suresh
9	Dr. Nagababu	Biochem	Nagababu
10	Dr. Babur Rao	ophthal.	Babur Rao
11	Dr. Sunitha	Anatomy	Sunitha
12	Dr. Karthik	Gen. Surgery	Karthik

Program Co-Ordinator
HOD

PRINCIPAL
MNR Medical College & Hospital
Fasalwadi, Sanga Reddy

Chairperson
Internal Quality Assurance Cell (IQAC)
MNR Medical College & Hospital



MNR Medical College

Fasalwadi, Sangareddy, Hyderabad, Telangana-502 294.

Certificate of Participation

This is to certify that

PATILLOLA Bhupal Reddy

has participated in A Workshop on

“Good Clinical Practice – Biomedical Waste Management”

on 06/10/2020 organised by ED Cell, conducted at MNR Medical College,

Fasalwadi, Sangareddy, Hyderabad, Telangana-502 294.

PRINCIPAL
MNR MEDICAL COLLEGE & HOSPITAL
FASALWADI, SANGAREDDY-502294

Shayyeesha
Internal Quality Assurance Cell (IQAC)
MNR Medical College & Hospital



MNR Medical College

Fasalwadi, Sangareddy, Hyderabad, Telangana-502 294.

Certificate of Participation

This is to certify that

_____ med ANUP RAO

has participated in A Workshop on

“Good Clinical Practice – Biomedical Waste Management”

on 06/10/2020 organised by ED Cell, conducted at MNR Medical College,
Fasalwadi, Sangareddy, Hyderabad, Telangana-502 294.

Principal

PRINCIPAL
MNR MEDICAL COLLEGE & HOSPITAL
FASALWADI, SANGAREDDY-502294

Chaverappa

Internal Quality Assurance Cell (IQAC)
MNR Medical College & Hospital



MNR Medical College

Fasalwadi, Sangareddy, Hyderabad, Telangana-502 294.

Certificate of Participation

This is to certify that

NUKALA NIKHITHA

has participated in A Workshop on

“Good Clinical Practice – Biomedical Waste Management”

on 06/10/2020 organised by ED Cell, conducted at MNR Medical College,
Fasalwadi, Sangareddy, Hyderabad, Telangana-502 294.

PRINCIPAL
MNR MEDICAL COLLEGE & HOSPITAL
FASALWADI, SANGAREDDY-502294

Principal

Chavafarapn
Internal Quality Assurance Cell (IQAC)
MNR Medical College & Hospital



MNR Medical College

Fasalwadi, Sangareddy, Hyderabad, Telangana-502 294.

Certificate of Participation

This is to certify that

YASHASREE PASUPULETI

has participated in A Workshop on

“Good Clinical Practice – Biomedical Waste Management”

on 06/10/2020 organised by ED Cell, conducted at MNR Medical College,
Fasalwadi, Sangareddy, Hyderabad, Telangana-502 294.

PRINCIPAL
MNR MEDICAL COLLEGE & HOSPITAL
FASALWADI, SANGAREDDY-502294

Principal

Chavverappan
Internal Quality Assurance Cell (IQAC)
MNR Medical College & Hospital



MNR Medical College

Fasalwadi, Sangareddy, Hyderabad, Telangana-502 294.

Certificate of Participation

This is to certify that

Dr. Sreenivas

has participated in A Workshop on

“Good Clinical Practice – Biomedical Waste Management”

on 06/10/2020 organised by ED Cell, conducted at MNR Medical College,
Fasalwadi, Sangareddy, Hyderabad, Telangana-502 294.

PRINCIPAL
MNR MEDICAL COLLEGE & HOSPITAL
FASALWADI, SANGAREDDY-502294

Principal

Chavertappa
Internal Quality Assurance Cell (IQAC)
MNR Medical College & Hospital



MNR Medical College

Fasalwadi, Sangareddy, Hyderabad, Telangana-502 294.

Certificate of Participation

This is to certify that

Dr. AMARENDRA PRASAD

has participated in A Workshop on

“Good Clinical Practice – Biomedical Waste Management”

on 06/10/2020 organised by ED Cell, conducted at MNR Medical College,
Fasalwadi, Sangareddy, Hyderabad, Telangana-502 294.

PRINCIPAL
MNR MEDICAL COLLEGE & HOSPITAL -
FASALWADI, SANGAREDDY-502294

Principal

Chavivera PN
Internal Quality Assurance Cell (IQAC)
MNR Medical College & Hospital



MNR MEDICAL COLLEGE & HOSPITAL

MNR Nagar, Fasalwadi, Sangareddy - 502 294, Sangareddy Dist. Telangana. India

Ph: + 85000 56667, (08455) 230523, 230527, 230524 Fax No. (08455) - 230555, 230533

CIRCULAR

Date: 07-01-2020

All the staff members and students are invited for a Seminar titled "Seminar on Sample transport and its significance on test results" to be conducted by the ED Cell on 8th January 2020. The venue of the presentation is Demo Hall-II, Biochemistry. Please take this opportunity to enlighten yourself and enhance your career.

Principal

PRINCIPAL
MNR Medical College & Hospital
Fasalwadi, Sanga Reddy

Copy to

- Medical Superintendent
- CEO
- Assistant Director
- Chief Academic Officer
- IQAC
- Concerned HODs
- Notice Boards

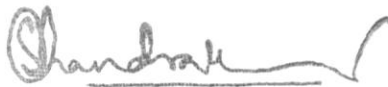

Chairperson
Internal Quality Assurance Cell (IQAC)
MNR Medical College & Hospital



MNR MEDICAL COLLEGE & HOSPITAL

MNR Nagar, Fasalwadi, Sangareddy - 502 294, Sangareddy Dist. Telangana. India

Ph: + 85000 56667, (08455) 230523, 230527, 230524 Fax No. (08455) - 230555, 230533

Date: 09/01/2020

PROGRAM REPORT

Program Name: "Seminar on Sample transport and its significance on test results"

Date of activity: 08/01/2020

Venue: Demo Hall-II, Biochemistry

Organized by: ED Cell

Resource person: Dr Chandrakumar S, Professor, Lab Consultant, Department of Pathology,
RVM Institute of Medical Sciences and Research Center, Siddipet,
Telangana

Number of participants: 94 Students & 14 Faculty

Objective of the program

The main objective of the program is Laboratory testing provides information about a patient's health to assist Physicians in diagnostic and therapeutic decisions. There are multiple Pre-Analytical factors associated with the handling and processing of laboratory specimens that can lead to test result inaccuracy. Strict adherence to all phases of proper collection and processing is essential for accurate test results.

Contents Delivered

- Specimen Collection:** a. Improper Patient Identification b. Incorrect Order of Draw c. Incorrect Tube Selection d. Traumatic draws leading to hemolysis e. Inadequate mixing or insufficient sample
- Specimen Handling/processing:** a. Serum tubes not thoroughly clotted before centrifugation b. Delay in Centrifugation c. Storing specimens in incorrect temperatures
- Specimen Transportation:** a. Frozen specimens thawing during transport b. Unspun specimens transported >2 hours from collection

Outcome of the program

The seminar concentrated on the Specimen Integrity is dependent on accurate pre-analytical processes to include patient preparation, specimen collection, handling, and transportation. Improper collection and handling of samples can give erroneous results and compromise the care of the patient. These guidelines cover some of the key steps in handling blood samples to provide optimal specimens for testing.

Chairperson

Internal Quality Assurance Cell (IQAC)
MNR Medical College & Hospital



PRINCIPAL
MNR Medical College & Hospital,
Fasalwadi, Sanga Reddy



MNR MEDICAL COLLEGE & HOSPITAL

MNR Nagar, Fasalwadi, Sangareddy - 502 294, Sangareddy Dist. Telangana. India

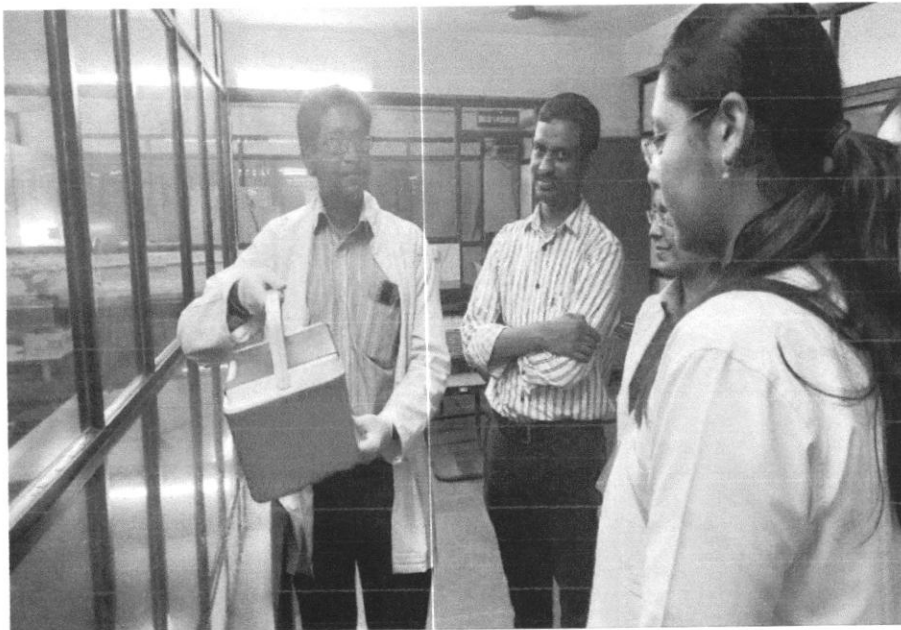
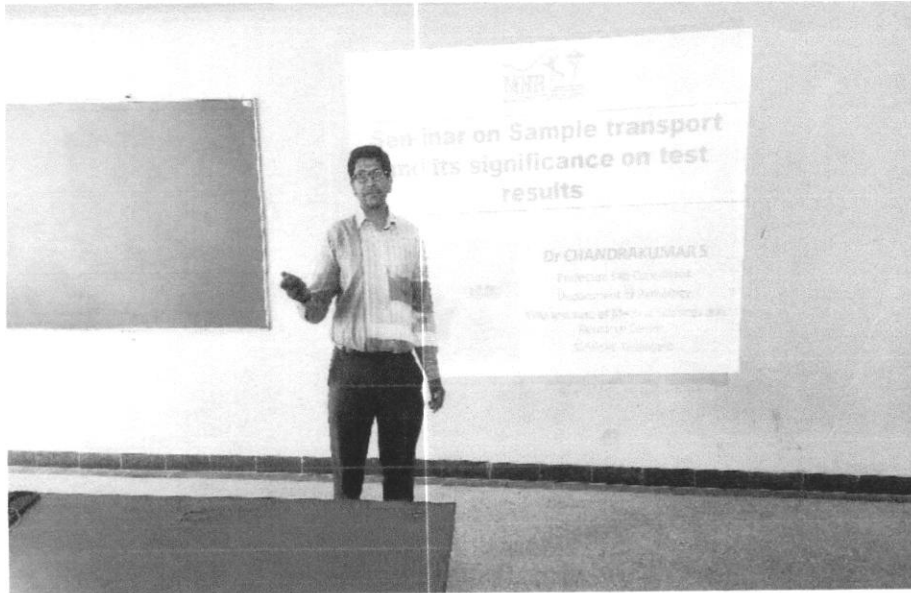
Ph: + 85000 56667, (08455) 230523, 230527, 230524 Fax No. (08455) - 230555, 230533



Program Co-Ordinator
HOD

Chairperson
Internal Quality Assurance Cell (IQAC)
MNR Medical College & Hospital



Chairperson
MEDICAL EDUCATION UNIT
MNR Medical College & Hospital



MNR MEDICAL COLLEGE & HOSPITAL

MNR Nagar, Fasalwadi, Sangareddy - 502 294, Sangareddy Dist. Telangana. India

Ph: + 85000 56667, (08455) 230523, 230527, 230524 Fax No. (08455) - 230555, 230533

S.No	Name of the participant	Course	Signature
1	BHEEMAVARAPU SAI SIVANI REDDY	MBBS	SIVANI
2	VEMURI MOHANCHANDRA BALAJI	MBBS	Chandra baba
3	TATIKONDA MEGHANA MANI CHANDANA	MBBS	Meghana
4	VALLOORI SRUSTI GRISELDA	MBBS	Srusti
5	AMTUL BASEER WAHEED	MBBS	Waheed
6	G.SPANDANA	MBBS	Spandana
7	CHANTI TEJA	MBBS	TEJA
8	D R NIHARIKA	MBBS	Niharika
9	THOTA SUHARSHITHA	MBBS	Suharshitha
10	MEDASANI CHINMAI	MBBS	CHINMAI
11	SUGOOR VAISHNAVI REDDY	MBBS	Vaishnavi
12	KATUKURI AKHIL REDDY	MBBS	Akhil
13	P.PRAVALIKA	MBBS	Pravalika
14	ILLENDULA NAGALALITYA	MBBS	Nagalalitya
15	P.ALEKYA CHOUDARY	MBBS	Alekya
16	CHELLOJU MAHESH	MBBS	Mahesh
17	KASULA LIKHITHA	MBBS	Likhitha
18	KIRTY BATTULA	MBBS	Kirty
19	MOHD MOHSIN	MBBS	Mohsin
20	M VIGNESWARI	MBBS	Vigneswari
21	SOMASANI VISHAL	MBBS	Vishal
22	AOUDARI AKSHITH	MBBS	Akshith
23	BHARATH CHANDRA KONDRU	MBBS	Bharath
24	INTI MOUNIKA	MBBS	Mounika
25	KANCHARLA SAMVEDA	MBBS	Samveda
26	H PRITHVI	MBBS	Prithvi



MNR MEDICAL COLLEGE & HOSPITAL

MNR Nagar, Fasalwadi, Sangareddy - 502 294, Sangareddy Dist. Telangana. India

Ph: + 85000 56667, (08455) 230523, 230527, 230524 Fax No. (08455) - 230555, 230533

27	G MEDHA	MBBS	Medha
28	AKSHAY KULKARNI	MBBS	Akshay
29	KONDRAJU JAYASRI MAHESHWARI	MBBS	Jayasri
30	KONDA KEERTHANA	MBBS	Keerthana
31	SIRIPURAPU CHANDRAHAAS	MBBS	Chandhaas
32	DOOSA KEERTHANA	MBBS	Keerthana
33	JANGITI SHIVANI	MBBS	Shivani
34	DORNALA SAI TEJA	MBBS	Sai Teja
35	NIMMAKURI SOWMYASRI	MBBS	Sowmya
36	KATHERVATH TARUN	MBBS	Tarun
37	RATHLA PARLAL	MBBS	Parlal
38	SAMMETA SRAVANI	MBBS	Sravani
39	NADIMPALLY HARSHITH REDDY	MBBS	Harshith
40	MOGURAM VAMSHI	MBBS	Vamshi
41	PAGIDI VANI	MBBS	P. Vani
42	SEELAM SUYUKTHA	MBBS	Suyuktha
43	KOLAGATLA BHAGYASRI	MBBS	Bhagyasri
44	BOMMANAPALLY INDIRA PRIYA DARSHINI	MBBS	Indira Priya
45	JAHNAVI PAKALAPATI	MBBS	Jahnavi
46	LAVUDI SANDHYA	MBBS	Sandhya
47	TALAKAYALA AISHWARYA	MBBS	Aishwarya
48	MALLEKHEDI BHAVANA SRAVANTHI	MBBS	Bhavana
49	D. JAHNAVI	MBBS	Jahnavi
50	AASHRITHA VANGARI	MBBS	Aashritha
51	TIPPARAJU NITHINSREE	MBBS	Nithinsree
52	ESHIKA DEVINENI	MBBS	Eshika
53	LEBAKA VYSHNAVI	MBBS	Vyshnavi
54	SANKET RAJENDRA BHISE	MBBS	Sanket
55	DASARI RITHIKA REDDY	MBBS	Rithika
56	SANDEEP REDDY PUCHAKAYALA	MBBS	Sandeep

PRINCIPAL
MNR Medical College & Hospital
Fasalwadi, Sangareddy

Chairperson
Internal Quality Assurance Cell (IQAC)
MNR Medical College & Hospital



MNR MEDICAL COLLEGE & HOSPITAL

MNR Nagar, Fasalwadi, Sangareddy - 502 294, Sangareddy Dist. Telangana. India

Ph: + 85000 56667, (08455) 230523, 230527, 230524 Fax No. (08455) - 230555, 230533

57	HIMA M	MBBS	M. Him
58	BERI RITHVIKA	MBBS	Rithvika
59	K NANDIKA	MBBS	Nandika
60	K. SHARATH KUMAR	MBBS	Sharath
61	YERVA MYTHILI	MBBS	Mythili
62	GODAS RAJESH	MBBS	Rajesh
63	CHINTA CHANDRA SEKHAR REDDY	MBBS	Chandra
64	KATLA VINAY KUMAR	MBBS	Vinay
65	JINCY MOHAN M.G.	MBBS	Jancy
66	DEEKSHITHA OBIREDDY	MBBS	Deekshitha
67	JAY KISHAN BHATI	MBBS	Jay
68	KORIVI AKSHARA PREETHI	MBBS	Preethi
69	SIRUPA LAHARI	MBBS	Lahari
70	VANKAMAMIDI BALA KEERTHANA	MBBS	Keethana
71	PUPPALA HARSHINI	MBBS	Harshini
72	GUGULOTH NEETU CHARAN	MBBS	Charan
73	JARUPULA GREESHMA	MBBS	Greeshma
74	PADMAJA SAI GATIGANTI	MBBS	Padmaja
75	VELAGAPUDI SAI KISHAN	MBBS	Kishan
76	BHARGAVA REDDY PALLAKI	MBBS	Bhargava
77	SAJJANAPU AISHWARYA	MBBS	Aishwarya
78	GUTTEDAR MEGHA VERONICA	MBBS	Veronica
79	ANGIREKULA SREEJA	MBBS	Sreeja
80	EDALA NIKESH KUMAR	MBBS	Nikesh
81	SUGURU VENKATA SATHYA KAUSTHUB	MBBS	Kausthub
82	KATAKAM PRIYESH REDDY	MBBS	Priyesh Reddy
83	T. AKANKSHA	MBBS	T. Akanksha
84	GOLLA MANASA	MBBS	Manasa
85	BANDARU LALASA SWETHA	MBBS	Swetha
86	ABBA RAVEENA	MBBS	Raveena
87	AYYAGARI SINDHU	MBBS	Sindhu
88	KATARI ASHRITH	MBBS	Ashritha
89	KOLACHALA KAMESWARI SAI CHETALI	MBBS	Kameswari

PRINCIPAL
MNR Medical College & Hospital
Fasalwadi, Sangareddy

Internal Quality Assurance Cell (IQAC)
MNR Medical College & Hospital

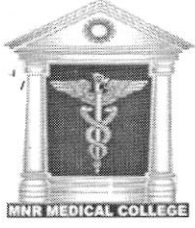

MNR MEDICAL COLLEGE & HOSPITAL

MNR Nagar, Fasalwadi, Sangareddy - 502 294, Sangareddy Dist. Telangana. India

Ph: + 85000 56667, (08455) 230523, 230527, 230524 Fax No. (08455) - 230555, 230533

90	VAISHNAVI TALLURI	MBBS	Jadhvi
91	BHANDAR DIVYA	MBBS	Dangan
92	MUDUTHANAPALLI NAGA PRIYA	MBBS	Daga Priya
93	NANDANI NANDAN	MBBS	Nandanam
94	NAGAMALLA MANISHA	mbbs.	Manisha

Program Co-Ordinator
HOD

FACULTY ATTENDANCE SHEET

Program Name: "Seminar on Sample transport and its significance on test results"

Date of activity: 08/01/2020

S.No	Name of the Faculty	Department	Signature
1	Dr. Bhavani	OBGYN	Bhavani
2	Dr. Pushpakumari	General med	Pushpa
3	Dr. Ilavaraj Yadav	General surgery	Ilavaraj
4	Dr. Sreenivas	General Surgery	Sreenivas
5	Dr. P. Suresh	microbiology	P. Suresh
6	Dr. Nagababu	Biochem	Nagababu
7	Dr. Kaethik	Gen. Surgery	Kaethik

PRINCIPAL
MNR Medical College & Hospital
Fasalwadi, Sanga Reddy

Chairperson
Internal Quality Assurance Cell (IQAC)
MNR Medical College & Hospital



MNR MEDICAL COLLEGE & HOSPITAL

MNR Nagar, Fasalwadi, Sangareddy - 502 294, Sangareddy Dist. Telangana. India

Ph: + 85000 56667, (08455) 230523, 230527, 230524 Fax No. (08455) - 230555, 230533

8	Dr. Keerthi	General medicine	Keerthi
9	Dr. Sunitha	Anatomy	Sunitha
10	Dr. Babu Rao	Ophthalmology	Babu R.
11	Dr. Umesh	OBGYN	Umesh
12	Dr. Rakesh Dhir	General med	Rakesh
13	Dr. Anurag Prasad	General surgery	Anurag
14	Dr. Prasanna Kumar	OBGYN	Prasanna Kumar

Program Co-Ordinator
HOD

PRINCIPAL
MNR Medical College & Hospital
Fasalwadi, Sangareddy

Chairperson
Internal Quality Assurance Cell (IQAC)
MNR Medical College & Hospital



MNR Medical College

Fasalwadi, Sangareddy, Hyderabad, Telangana-502 294.

Certificate of Participation

This is to certify that

Doosu Keerthana.

has participated in A Workshop on

“Seminar on Sample transport and its significance on test results”

on 08/01/2020organised by ED Cell, conducted at MNR Medical College,
Fasalwadi, Sangareddy, Hyderabad, Telangana-502 294.



Chairperson
Internal Quality Assurance Cell (IQAC),
MNR Medical College & Hospital



PRINCIPAL
Principal
MNR MEDICAL COLLEGE & HOSPITAL
FASALWADI, SANGAREDDY-502294



MNR Medical College

Fasalwadi, Sangareddy, Hyderabad, Telangana-502 294.

Certificate of Participation

This is to certify that

A. Sindhu.

has participated in A Workshop on

“Seminar on Sample transport and its significance on test results”

on 08/01/2020organised by ED Cell, conducted at MNR Medical College,
Fasalwadi, Sangareddy, Hyderabad, Telangana-502 294.

Chairperson
Internal Quality Assurance Cell (IQAC),
MNR Medical College & Hospital

PRINCIPAL
Principal
MNR MEDICAL COLLEGE & HOSPITAL
FASALWADI, SANGAREDDY, TELANGANA



MNR Medical College

Fasalwadi, Sangareddy, Hyderabad, Telangana-502 294.

Certificate of Participation

This is to certify that

B. Indira Priyadarshini
has participated in A Workshop on

“Seminar on Sample transport and its significance on test results”
on 08/01/2020organised by ED Cell, conducted at MNR Medical College,
Fasalwadi, Sangareddy, Hyderabad, Telangana-502 294.

Chairperson
Internal Quality Assurance Cell (IQAC),
MNR Medical College & Hospital

PRINCIPAL
Principal
MNR MEDICAL COLLEGE & HOSPITAL
FASALWADI, SANGAREDDY, TELANGANA



MNR Medical College

Fasalwadi, Sangareddy, Hyderabad, Telangana-502 294.

Certificate of Participation

This is to certify that

Dr. Ilaicho Yadav

has participated in A Workshop on

“Seminar on Sample transport and its significance on test results”

on 08/01/2020organised by ED Cell, conducted at MNR Medical College,
Fasalwadi, Sangareddy, Hyderabad, Telangana-502 294.



Chairperson
Internal Quality Assurance Cell (IQAC),
Chivener
MNR Medical College & Hospital



PRINCIPAL
Principal
MNR MEDICAL COLLEGE & HOSPITAL
FASALWADI, SANGAREDDY, TELANGANA



MNR Medical College

Fasalwadi, Sangareddy, Hyderabad, Telangana-502 294.

Certificate of Participation

This is to certify that

Dr. Bhawan

has participated in A Workshop on

“Seminar on Sample transport and its significance on test results”

on 08/01/2020 organised by ED Cell, conducted at MNR Medical College,
Fasalwadi, Sangareddy, Hyderabad, Telangana-502 294.



Chairperson
Internal Quality Assurance Cell (IQAC),
MNR Medical College & Hospital



PRINCIPAL
Principal
MNR MEDICAL COLLEGE & HOSPITAL
FASALWADI, SANGAREDDY, TELANGANA



MNR Medical College

Fasalwadi, Sangareddy, Hyderabad, Telangana-502 294.

Certificate of Participation

This is to certify that

Dr. Deepika.

has participated in A Workshop on

“Seminar on Sample transport and its significance on test results”

on 08/01/2020organised by ED Cell, conducted at MNR Medical College,
Fasalwadi, Sangareddy, Hyderabad, Telangana-502 294.



Chairperson
Internal Quality Assurance Cell (IQAC),
convener
MNR Medical College & Hospital



PRINCIPAL
Principal
MNR MEDICAL COLLEGE & HOSPITAL
FASALWADI, SANGAREDDY - 502294



MNR MEDICAL COLLEGE & HOSPITAL

MNR Nagar, Fasalwadi, Sangareddy - 502 294, Sangareddy Dist. Telangana. India

Ph: + 85000 56667, (08455) 230523, 230527, 230524 Fax No. (08455) - 230555, 230533

CIRCULAR

Date: 11-03-2020

All the staff members and students are invited for a seminar titled "Seminar on Writing a research paper" to be conducted by the R&D Cell on 12th March 2020. The venue of the presentation is Demo Hall-II, Biochemistry. Please take this opportunity to enlighten yourself and enhance your career.

Principal

Copy to

- Medical Superintendent
- CEO
- Assistant Director
- Chief Academic Officer
- IQAC
- Concerned HODs
- Notice Boards

Chairperson
Internal Quality Assurance Cell (IQAC)
MNR Medical College & Hospital

PRINCIPAL
MNR Medical College & Hospital
Fasalwadi, Sangareddy



MNR MEDICAL COLLEGE & HOSPITAL

MNR Nagar, Fasalwadi, Sangareddy - 502 294, Sangareddy Dist. Telangana. India

Ph: + 85000 56667, (08455) 230523, 230527, 230524 Fax No. (08455) - 230555, 230533

Date: 13/03/2020

PROGRAM REPORT

Program Name: "Seminar on writing a research paper"

Date of activity: 12/03/2020

Venue: Demo Hall-II, Biochemistry

Organized by: R&D Cell

Resource person: Dr Chandrakumar S, Professor, Lab Consultant, Department of Pathology,
RVM Institute of Medical Sciences and Research Center, Siddipet, Telangana

Number of participants: 98 Students & 13 Faculty

Objective of the program

The main objective of the program is to know about research methodology and its importance. One of the most important aspects of a thesis, dissertation or research paper is the correct formulation of the aims and objectives. This is because your aims and objectives will establish the scope, depth and direction that your research will ultimately take.

Contents Delivered

- Understand the assignment
- Choose a research paper topic
- Conduct preliminary research
- Create a research paper outline
- Paragraph structure
- Citing sources

Outcome of the program

All the participants were welcomed and the event started with good note in the presence of Principal MNR Medical College & Hospital. The Event covered the aspects of the importance of research and research paper writing in medical field. The event also covered the importance of the research, quality of research, research paper writing and publishing in reputed journal. The

PRINCIPAL
MNR Medical College & Hospital
Fasalwadi, Sangareddy

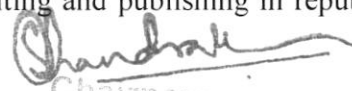
Chairperson
Internal Quality Assurance Cell (IQAC)
MNR Medical College & Hospital



MNR MEDICAL COLLEGE & HOSPITAL

MNR Nagar, Fasalwadi, Sangareddy - 502 294, Sangareddy Dist. Telangana. India

Ph: + 85000 56667, (08455) 230523, 230527, 230524 Fax No. (08455) - 230555, 230533

overall methods to write paper, heading, domains to be considered while drafting paper and how to avoid plagiarism to enhance the uniqueness and quality of paper were discussed.

Chairperson
Internal Quality Assurance Cell (IQAC)
MNR Medical College & Hospital

PRINCIPAL
MNR Medical College & Hospital
Fasalwadi, Sangareddy



MNR MEDICAL COLLEGE & HOSPITAL

MNR Nagar, Fasalwadi, Sangareddy - 502 294, Sangareddy Dist. Telangana. India

Ph: + 85000 56667, (08455) 230523, 230527, 230524 Fax No. (08455) - 230555, 230533

be considered while drafting paper and how to avoid plagiarism to enhance the uniqueness and quality of paper were discussed.

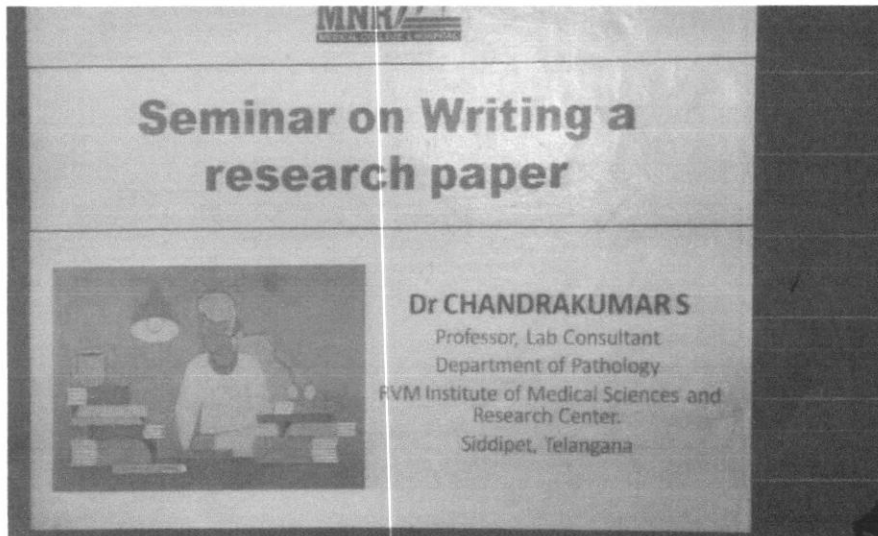

Chandrasekhar
Chairperson
Internal Quality Assurance Cell (IQAC)
MNR Medical College & Hospital

[Signature]
PRINCIPAL
MNR MEDICAL COLLEGE & HOSPITAL
FASALWADI, SANGAREDDY-502294

Chairperson
MEDICAL EDUCATION UNIT
MNR Medical College & Hospital

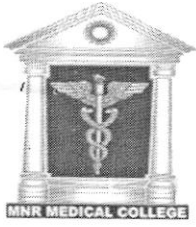

MNR MEDICAL COLLEGE & HOSPITAL

MNR Nagar, Fasalwadi, Sangareddy - 502 294, Sangareddy Dist. Telangana. India

Ph: + 85000 56667, (08455) 230523, 230527, 230524 Fax No. (08455) - 230555, 230533

STUDENT ATTENDANCE SHEET

Program Name: "Seminar on writing a research paper"

Date of activity: 12/03/2020

S.No	Name of the participant	Course	Signature
1	PANDARABOYINA SAI KRISHNA TEJA	MBBS	Sai krishna teja
2	BHEEMAVARAPU SAI SIVANI REDDY	MBBS	Bheemavaru
3	VEMURI MOHANCHANDRA BALAJI	MBBS	Mohan
4	TATIKONDA MEGHANA MANI CHANDANA	MBBS	Meghana
5	VALLOORI SRUSTI GRISELDA	MBBS	Srusti
6	AMTUL BASEER WAHEED	MBBS	Baseer
7	G.SPANDANA	MBBS	Spandana
8	CHANTI TEJA	MBBS	Teja
9	D R NIHARIKA	MBBS	Niharika
10	THOTA SUHARSHITHA	MBBS	Suharshitha
11	MEDASANI CHINMAI	MBBS	Chinmai
12	SUGOOR VAISHNAVI REDDY	MBBS	Sugoor
13	KATUKURI AKHIL REDDY	MBBS	Akhil
14	P.PRAVALIKA	MBBS	Pravalika
15	ILLENDULA NAGALALITYA	MBBS	Lali
16	P.ALEKYA CHOUDARY	MBBS	Aleky
17	CHELLOJU MAHESH	MBBS	Mahesh
18	KASULA LIKHITHA	MBBS	Likitha
19	KIRTY BATTULA	MBBS	Kirty
20	MOHD MOHSIN	MBBS	Mohsin
21	M VIGNESWARI	MBBS	VIGNESWARI
22	SOMASANI VISHAL	MBBS	Vishal
23	AODARI AKSHITH	MBBS	Akshith

(Handwritten signature)

PRINCIPAL
MNR Medical College & Hospital
Fasalwadi, Sanga Reddy

Internal Quality Assurance Cell (IQAC)
MNR Medical College & Hospital

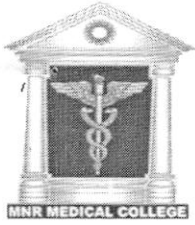

MNR MEDICAL COLLEGE & HOSPITAL

MNR Nagar, Fasalwadi, Sangareddy - 502 294, Sangareddy Dist. Telangana. India

Ph: + 85000 56667, (08455) 230523, 230527, 230524 Fax No. (08455) - 230555, 230533

24	BHARATH CHANDRA KONDRU	MBBS	Bharath
25	INTI MOUNIKA	MBBS	Moanika
26	KANCHARLA SAMVEDA	MBBS	Samveda
27	H PRITHVI	MBBS	Prithvi
28	G MEDHA	MBBS	Medha
29	AKSHAY KULKARNI	MBBS	Akshay
30	KONDRAJU JAYASRI MAHESHWARI	MBBS	Jayashri
31	KONDA KEERTHANA	MBBS	Keerthana
32	SIRIPURAPU CHANDRAHAAS	MBBS	Chandrabhaas
33	DOOSA KEERTHANA	MBBS	Keerthana
34	JANGITI SHIVANI	MBBS	Shivani
35	DORNALA SAI TEJA	MBBS	Sai Teja
36	NIMMAKURI SOWMYASRI	MBBS	Sowmya
37	KATHERVATH TARUN	MBBS	Tarun
38	RATHLA PARLAL	MBBS	Rathla Parlal
39	SAMMETA SRAVANI	MBBS	Sravani
40	NADIMPALLY HARSHITH REDDY	MBBS	Harshith
41	MOGURAM VAMSHI	MBBS	Vamsi
42	PAGIDI VANI	MBBS	Vani
43	SEELAM SUYUKTHA	MBBS	S. Suyuktha
44	KOLAGATLA BHAGYASRI	MBBS	Bhagya
45	BOMMANAPALLY INDIRA PRIYA DARSHINI	MBBS	Priya Darshini
46	JAHNAVI PAKALAPATI	MBBS	Jahnavi
47	LAVUDI SANDHYA	MBBS	Sandhya
48	TALAKAYALA AISHWARYA	MBBS	Aishwarya
49	MALLEKHEDI BHAVANA SRAVANTHI	MBBS	Bhavani
50	D. JAHNAVI	MBBS	Jahnavi
51	AASHRITHA VANGARI	MBBS	Aashritha
52	TIPPARAJU NITHINSREE	MBBS	Nithin
53	ESHIKA DEVINENI	MBBS	Eshika

Chandrabhaas

PRINCIPAL
MNR Medical College & Hospital
Fasalwadi, Sangareddy

Chairperson
Internal Quality Assurance Cell (IQAC)
MNR Medical College & Hospital



MNR MEDICAL COLLEGE & HOSPITAL

MNR Nagar, Fasalwadi, Sangareddy - 502 294, Sangareddy Dist. Telangana. India

Ph: + 85000 56667, (08455) 230523, 230527, 230524 Fax No. (08455) - 230555, 230533

54	LEBAKA VYSHNAVI	MBBS	Vyshnavi
55	SANKET RAJENDRA BHISE	MBBS	Rajendra
56	DASARI RITHIKA REDDY	MBBS	Rithika Reddy
57	SANDEEP REDDY PUCHAKAYALA	MBBS	Sandeep
58	HIMA M	MBBS	Hima
59	BERI RITHVIKA	MBBS	Rithvika Beri
60	K NANDIKA	MBBS	Nandika
61	K. SHARATH KUMAR	MBBS	Sharath
62	YERVA MYTHILI	MBBS	Mythili
63	GODAS RAJESH	MBBS	Rajesh
64	CHINTA CHANDRA SEKHA REDDY	MBBS	Shekhar
65	KATLA VINAY KUMAR	MBBS	Vinay Kumar
66	JINCY MOHAN M.G.	MBBS	Mohan
67	DEEKSHITHA OBIREDDY	MBBS	Obi
68	JAY KISHAN BHATI	MBBS	Kishan
69	KORIVI AKSHARA PREETHI	MBBS	Preethi
70	SIRUPA LAHARI	MBBS	Sirupa
71	VANKAMAMIDI BALA KEERTHANA	MBBS	Keerthana
72	PUPPALA HARSHINI	MBBS	Harshini
73	GUGULOTH NEETU CHARAN	MBBS	Neetu
74	JARUPULA GREESHMA	MBBS	Greeshma
75	PADMAJA SAI GATIGANTI	MBBS	Padma
76	VELAGAPUDI SAI KISHAN	MBBS	Kishan
77	BHARGAVA REDDY PALLAKI	MBBS	Bhargava
78	SAJJANAPU AISHWARYA	MBBS	Aishwarya
79	GUTTEDAR MEGHA VERONICA	MBBS	Megha
80	ANGIREKULA SREEJA	MBBS	Sreeja
81	EDALA NIKESH KUMAR	MBBS	Nikesh
82	SUGURU VENKATA SATHYA KAUSTHUB	MBBS	Kausthub
83	KATAKAM PRIYESH REDDY	MBBS	Priyesh Reddy
84	T. AKANKSHA	MBBS	Akanksha
85	GOLLA MANASA	MBBS	Manasa
86	BANDARU LALASA SWETHA	MBBS	Swetha

Chandra

PRINCIPAL
MNR Medical College & Hospital
Fasalwadi, Sangareddy

Chairperson
Internal Quality Assurance
MNR Medical College & Hospital

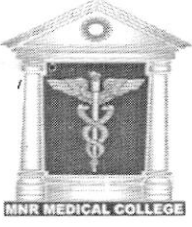

MNR MEDICAL COLLEGE & HOSPITAL

MNR Nagar, Fasalwadi, Sangareddy - 502 294, Sangareddy Dist. Telangana. India

Ph: + 85000 56667, (08455) 230523, 230527, 230524 Fax No. (08455) - 230555, 230533

87	ABBA RAVEENA	MBBS	Raveena
88	AYYAGARI SINDHU	MBBS	sindhu
89	KATARI ASHRITH	MBBS	Aashith
90	KOLACHALA KAMESWARI SAI CHETALI	MBBS	sai chetali
91	VAISHNAVI TALLURI	MBBS	Vaishnavi
92	BHANDAR DIVYA	MBBS	Divya
93	MUDUTHANAPALLI NAGA PRIYA	MBBS	NAGA PRIYA
94	NANDANI NANDAN	MBBS	Nandan
95	NAGAMALLA MANISHA	MBBS	Manisha
96	KUKKUNOORI DHARANI	MBBS	Dharani

Program Co-Ordinator
HOD

Chairperson
Internal Quality Assurance Cell (IQAC)
MNR Medical College & Hospital

PRINCIPAL
MNR Medical College & Hospital
Fasalwadi, Sanga Reddy

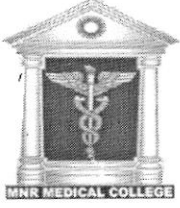

MNR MEDICAL COLLEGE & HOSPITAL

MNR Nagar, Fasalwadi, Sangareddy - 502 294, Sangareddy Dist. Telangana. India

Ph: + 85000 56667, (08455) 230523, 230527, 230524 Fax No. (08455) - 230555, 230533

FACULTY ATTENDANCE SHEET

Program Name: "Seminar on writing a research paper"

Date of activity: 12/03/2020

S.No	Name of the Faculty	Branch	Signature
1	Dr. Indira	Genl medicine	Indira
2	Dr. Eshika	Paediat	Eshika
3	Dr. Nagababu	Biotech	Nagababu
4	Dr. Babu Rao	Ophthalm	Babu
5	Dr. Sindhu	Gen. Surg	Sindhu
6	Dr. P. Kuresh	microbiology	P Kuresh
7	Dr. Dharani	Ortho	Dharani
8	Dr. Harish Yadav	Genl medicine	Harish
9	Dr. Sai Sivani	Gen med.	Sai Sivani
10	Dr. Ananda Prasad	Genl Surg	Ananda
11	Dr. Bhavani	OB&G	Bhavani
12	Dr. Sunitha	Anatomy	Sunitha
13	Dr. Bhaktavar	Genl Surg	Bhaktavar

Program Co-Ordinator

HOD



MNR Medical College

Fasalwadi, Sangareddy, Hyderabad, Telangana-502 294.

Certificate of Participation

This is to certify that

Dr. RUDRAPRASAD

has participated in A Seminar on

“Writing a Research Paper”

on 12/03/2020 organised by R&D Cell, conducted at MNR Medical College,
Fasalwadi, Sangareddy, Hyderabad, Telangana-502 294.

[Signature]

Chairperson
Convener

[Signature]
Principal

PRINCIPAL

MNR MEDICAL COLLEGE & HOSPITAL

12/03/2020

Chairperson
MNR Medical College & Hospital

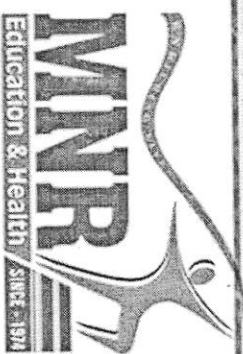

MNR Medical College

Fasalwadi, Sangareddy, Hyderabad, Telangana-502 294.

Certificate of Participation

This is to certify that

_____ PANDARA BOYINA SAI KRISHNA TEJA _____

has participated in A Seminar on

“Writing a Research Paper”

on 12/03/2020 organised by R&D Cell, conducted at MNR Medical College,
Fasalwadi, Sangareddy, Hyderabad, Telangana-502 294.

[Signature]

Chairperson
MNR Medical College & Hospital

Convenor

[Signature]

Principal
PRINCIPAL

MNR MEDICAL COLLEGE & HOSPITAL

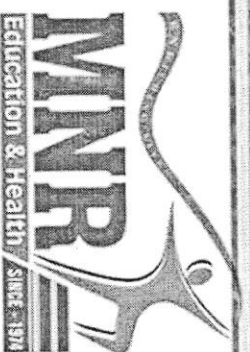

MNR Medical College

Fasalwadi, Sangareddy, Hyderabad, Telangana-502 294.

Certificate of Participation

This is to certify that

BHEEMAVARAPU SAI SIVANI REDDY

has participated in A Seminar on

“Writing a Research Paper”

on 12/03/2020 organised by R&D Cell, conducted at MNR Medical College,
Fasalwadi, Sangareddy, Hyderabad, Telangana-502 294.

Chaitanya

Chairperson
Medical Quality Assurance Cell (MQR)

Convener

Chaitanya

Principal

PRINCIPAL

MNR MEDICAL COLLEGE & HOSPITAL

MNR Medical College & Hospital
Fasalwadi, Sangareddy, Hyderabad, Telangana-502 294.



MNR Medical College

Fasalwadi, Sangareddy, Hyderabad, Telangana-502 294.

Certificate of Participation

This is to certify that

_____ YEMURI MOHANCHANDRA BABAI _____

has participated in A Seminar on

“Writing a Research Paper”

on 12/03/2020 organised by R&D Cell, conducted at MNR Medical College,
Fasalwadi, Sangareddy, Hyderabad, Telangana-502 294.

Chandrab

Chairperson
Medical Quality Assurance Cell

Convener

SPK

Principal

PRINCIPAL

MNR MEDICAL COLLEGE & HOSPITAL

MNR Medical College & Hospital
Fasalwadi, Sangareddy, Hyderabad, Telangana-502 294.

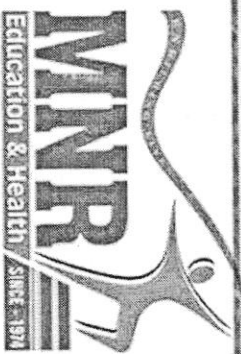

MNR Medical College

Fasalwadi, Sangareddy, Hyderabad, Telangana-502 294.

Certificate of Participation

This is to certify that

Dr. NAGA BABU

has participated in A Seminar on

“Writing a Research Paper”

on 12/03/2020 organised by R&D Cell, conducted at MNR Medical College,
Fasalwadi, Sangareddy, Hyderabad, Telangana-502 294.

Signature

Chairperson
Medical Quality Assurance Cell

Convener

Signature

Principal

MNR MEDICAL COLLEGE & HOSPITAL

MNR Medical College & Hospital

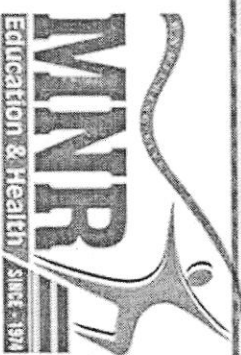

MNR Medical College

Fasalwadi, Sangareddy, Hyderabad, Telangana-502 294.

Certificate of Participation

This is to certify that

Dr. BABU RAO

has participated in A Seminar on

“Writing a Research Paper”

on 12/03/2020 organised by R&D Cell, conducted at MNR Medical College,
Fasalwadi, Sangareddy, Hyderabad, Telangana-502 294.

[Signature]

Chairperson
Medical Quality Assurance Cell

Convener

[Signature]
Principal

PRINCIPAL
MNR MEDICAL COLLEGE & HOSPITAL

MNR Medical College R & D Cell
Call 1184

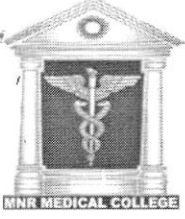

MNR MEDICAL COLLEGE & HOSPITAL

MNR Nagar, Fasalwadi, Sangareddy - 502 294, Sangareddy Dist. Telangana. India

Ph: + 85000 56667, (08455) 230523, 230527, 230524 Fax No. (08455) - 230555, 230533

CIRCULAR

Date: 18-02-2020

All the staff members and students are invited for a seminar titled "Good clinical practice- sterilization" to be conducted by the ED Cell on 19th February 2020. The venue of the presentation is Demo Hall-II, Biochemistry. Please take this opportunity to enlighten yourself and enhance your career.

Principal

Copy to

- Medical Superintendent
- CEO
- Assistant Director
- Chief Academic Officer
- IQAC
- Concerned HODs
- Notice Boards



Chairperson

Internal Quality Assurance Cell (IQAC)

MNR Medical College & Hospital

PRINCIPAL
MNR Medical College & Hospital
Fasalwadi, Sangareddy



MNR MEDICAL COLLEGE & HOSPITAL

MNR Nagar, Fasalwadi, Sangareddy - 502 294, Sangareddy Dist. Telangana. India

Ph: + 85000 56667, (08455) 230523, 230527, 230524 Fax No. (08455) - 230555, 230533

Date: 20/02/2020

PROGRAM REPORT

Program Name: "Good clinical practice- sterilization"

Date of activity: 19/02/2020

Venue: Demo Hall-II, Biochemistry

Organized by: ED Cell

Resource person: Dr Suresh P, Consultant Microbiologist, Apollo Laboratories, Bangalore.

Number of participants: 89 Students & 14 Faculty

Objective of the program

- Adopt good and safe operating procedures and recording systems
- Prevent unsafe and hazardous acts which could affect individuals and/or property.
- Prevent equipment errors in measurements.
- Prevent human errors in the performance of the job.

Contents Delivered

- Management-Responsibilities.
- Sponsor-Responsibilities.
- Study Director-Responsibilities.
- Principal Investigator-Responsibilities.
- Study Personnel-Responsibilities.

Outcome of the program

The seminar concentrated on the good laboratory practice in sterilization. The importance of sterilization in patients care and also reducing the nosocomial infections. The seminar ended with happy note and take home message of good laboratory practice on sterilization at hospital.

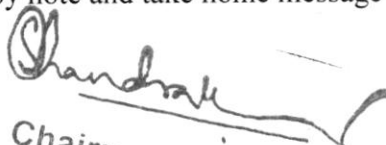
Chairperson
Internal Quality Assurance Cell (IQAC)
MNR Medical College & Hospital



PRINCIPAL
MNR Medical College & Hospital
Fasalwadi, Sangareddy



MNR MEDICAL COLLEGE & HOSPITAL

MNR Nagar, Fasalwadi, Sangareddy - 502 294, Sangareddy Dist. Telangana. India

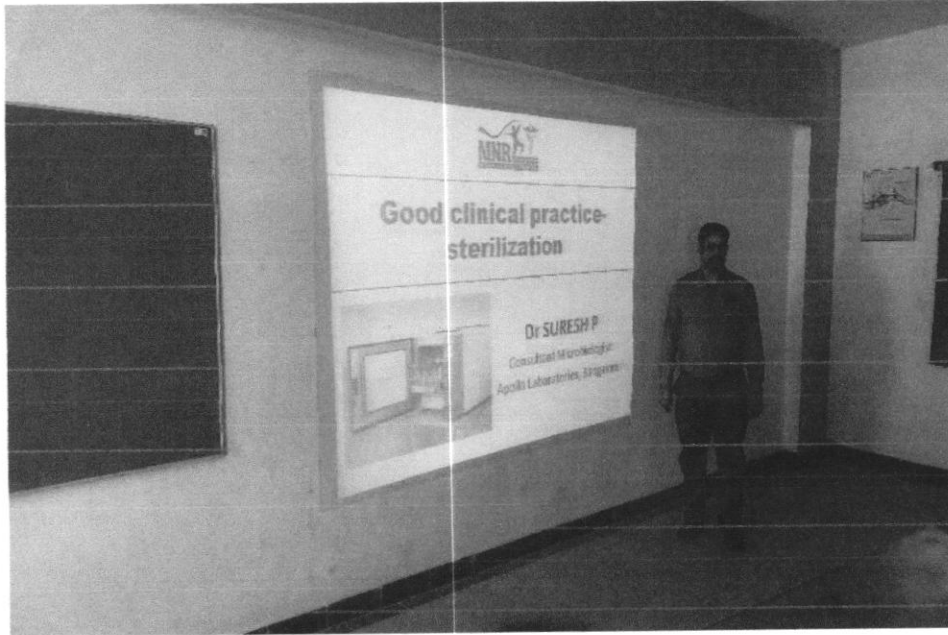
Ph: + 85000 56667, (08455) 230523, 230527, 230524 Fax No. (08455) - 230555, 230533



Chandrabhanth
Internal Quality
MNR Medical College & Hospital

MC
PRINCIPAL

MNR MEDICAL COLLEGE & HOSPITAL
FASALWADI, SANGAREDDY - 502294

Chairperson
MEDICAL EDUCATION UNIT
MNR Medical College & Hospital

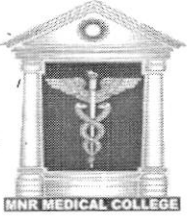

MNR MEDICAL COLLEGE & HOSPITAL

MNR Nagar, Fasalwadi, Sangareddy - 502 294, Sangareddy Dist. Telangana. India

Ph: + 85000 56667, (08455) 230523, 230527, 230524 Fax No. (08455) - 230555, 230533

STUDENT ATTENDANCE SHEET

Program Name: "Good clinical practice- sterilization"

Date of activity: 19/02/2020

S.No	Name of the participant	Course	Signature
1	KURELLI PAVAN KALYAN	MBBS	Pavan
2	PATLOLLA BHOOPAL REDDY	MBBS	Bhopal
3	MEDI ANUP RAO	MBBS	Anup Rao M
4	NUKALA NIHITHA	MBBS	Niitha
5	YASHASREE PASUPULETI	MBBS	Nikutin
6	SOMA NITISH REDDY	MBBS	Soma
7	ROSHAN KUMAR M	MBBS	Roshan
8	BANDYALA SAIKUMAR	MBBS	Saikumar
9	NIKHITA NADIMPALLI	MBBS	Nikhita
10	MUSKU NANDINI	MBBS	Nandini
11	AKULA PALLAVI	MBBS	Pallavi
12	KONGALA RISHITHA	MBBS	Rishitha
13	GOLKONDA KARTHIK	MBBS	Gokarthik
14	BIRADAR SAIKUMAR	MBBS	Saikumar
15	NAIKOTI RAHUL	MBBS	Rahul
16	KOTHURU SUSHANTH	MBBS	Sushanth
17	SEVELLA MANOJ KUMAR	MBBS	Manoj
18	DANDYAR SHIVA PRASAD	MBBS	Shivap
19	BURRA JEEVANA	MBBS	Jeevana
20	MALELA BHANU PRASAD GOUD	MBBS	Bhanu
21	AKKENAPALLY RAJASHEKARACHARY	MBBS	Rajasekar

Chandra

PRINCIPAL
MNR Medical College & Hospital
Fasalwadi, Sanga Reddy



MNR MEDICAL COLLEGE & HOSPITAL

MNR Nagar, Fasalwadi, Sangareddy - 502 294, Sangareddy Dist. Telangana. India

Ph: + 85000 56667, (08455) 230523, 230527, 230524 Fax No. (08455) - 230555, 230533

22	JANGITI MANEESHA	MBBS	J Manish
23	BOLLOJU GURU PRASAD	MBBS	Guru Prasad
24	P SRILEKHA	MBBS	Srilekha
25	MORAM STOTRA PRIYA	MBBS	Priya
26	RACHANA RAPOLU	MBBS	Rachana
27	M MANISHA GOUD	MBBS	Manishagoud
28	OGGU SRIKANTH	MBBS	Srikanth
29	EDIGA SAI CHANDANA	MBBS	E. Chandana
30	MARUGONDA SAKETH VARMA	MBBS	Saketh
31	ANUMALLA MANASWINI	MBBS	Anamswini
32	BANDI NAVEEN KUMAR	MBBS	Naveen
33	SHAIK HASNAD BABA	MBBS	Hasnab
34	MAHEEN SULTANA	MBBS	Mahesana
35	BANOTH VASANTH KUMAR	MBBS	Vasanth
36	B ANJALI NAIK	MBBS	Anjali
37	MALAGARI MANEESHA	MBBS	Maneesha
38	CHINMAYEE DESAI	MBBS	Chinmayee
39	GAJULA SRI HARSHA CHAKRAVARTHY	MBBS	Harsha
40	MALKA HARSHITHA	MBBS	Harshitha
41	MENDI DEEKSHITHA	MBBS	Deekshitha
42	YATHAM SRI HARIKA	MBBS	Harika
43	J AISHWARYA	MBBS	Aishwarya
44	MUTHERAGALLA PRATHYUSHA	MBBS	M Prathysha
45	SEELAM LAXMI PRIYA	MBBS	Lakshipriya
46	BANDILA V V S TANMAIYEE	MBBS	Tanmayee
47	GADDAM SRINIVAS	MBBS	Srinivas
48	SK AJEETH MUSHRAF	MBBS	Ajeeth

(Handwritten signature)

(Handwritten signature)
PRINCIPAL
MNR Medical College & Hospital
Fasalwadi, Sangareddy



MNR MEDICAL COLLEGE & HOSPITAL

MNR Nagar, Fasalwadi, Sangareddy - 502 294, Sangareddy Dist. Telangana. India

Ph: + 85000 56667, (08455) 230523, 230527, 230524 Fax No. (08455) - 230555, 230533

49	GAJULA CHANDRA HASA	MBBS	Chandra
50	SALADI SAI VENKATA SOWMYA SARADA	MBBS	Sarada
51	SHRUTI BOSE	MBBS	Bose
52	DODDIPALLI BHANU PRAKASH REDDY	MBBS	Drash
53	SABHADU SUSHMITHA	MBBS	Sushmitha
54	PRIYANKA RAJ KUMAWAT	MBBS	Priyanka
55	MUGA RITHIKA	MBBS	Rithika
56	R PRANITH KAMLAY	MBBS	R Kamlaya
57	MARPALIKAR YOGESHWARI CHANDRAKANT	MBBS	Y Chandrakant
58	RAJA RAJESWAR REDDY ATTLA	M.B.B.S	Rajeswar
59	NABAMITA CHAKRABORTY	MBBS	Nabamita
60	SHUBAM DILIP SHINDE	MBBS	D Shinde
61	BODDAM CHANDRALEKHA	MBBS	Chandralekha
62	ROHIT JAJU	MBBS	Rohit
63	NABA KHANAM	MBBS	Naba Khanam
64	JAKAREGARI SOLOMON SUMAHITH SURATHAN	MBBS	J Surathan
65	AMBATI SAI KEERTHANA	MBBS	Sai Keethana
66	DAKSHA LONAVATH	MBBS	Daksha Lonavath
67	ESLAVATH GANESH KUMAR	MBBS	E Ganesh
68	PANDHIPATI RAMYAPRIYA	MBBS	P
69	GOLAMARI PRANAY PAUL REDDY	MBBS	Pranay P
70	CHETANA MAHARANA	MBBS	Chetana
71	RANOO PRIYAMBADA BISWAL	MBBS	R Biswal
72	KUKUDALA KEERTHI	MBBS	Keerthi
73	HAJIRA NOOREIN	MBBS	Hajira Noorein
74	GRUSHA VARMA	MBBS	Grusha Varma
75	DURGAPPAGARI KIRANGOUD	MBBS	D Goud
76	DANUGURI UMA	MBBS	D Uma
77	APPADI DIVYA	MBBS	Divya
78	GIDDI RAM VARSHITH REDDY	MBBS	G Ram

Chandrasekhar

Principal
MNR Medical College & Hospital
Fasalwadi, Sangareddy



MNR MEDICAL COLLEGE & HOSPITAL

MNR Nagar, Fasalwadi, Sangareddy - 502 294, Sangareddy Dist. Telangana. India

Ph: + 85000 56667, (08455) 230523, 230527, 230524 Fax No. (08455) - 230555, 230533

79	KOTHAPALLI SAICHANDANA	MBBS	Saichandana
80	POLE MOUNIKA	MBBS	Mounika
81	ADELLI SRIDHAR	M.B.B.S	Sridhar
82	BHUKYA HARSHA	MBBS	Harsha
83	PERUMANDLA HANISHA	MBBS	Hanisha
84	GEENUKUNTA AMRUTH KUMAR	M. B. B. S	G. Amruth
85	JOGINAPALLY GAYATHRI	MBBS	J. Gayathri
86	GUNTOJU SUDEEP	MBBS	Sudeep
87	NUTALAPATI MOHAN KRISHNA	MBBS	Mohan Krishna
88	PRANEESHA REDDY KANDI	MBBS	P. Kandi
89	RAPAKA SHERLY	MBBS	Sherly

Chairperson
Internal Quality Assurance Cell (IQAC)
MNR Medical College & Hospital

Program Co-Ordinator

HOD

PRINCIPAL
MNR Medical College & Hospital
Fasalwadi, Sangareddy



MNR MEDICAL COLLEGE & HOSPITAL

MNR Nagar, Fasalwadi, Sangareddy - 502 294, Sangareddy Dist. Telangana. India

Ph: + 85000 56667, (08455) 230523, 230527, 230524 Fax No. (08455) - 230555, 230533

FACULTY ATTENDANCE SHEET

Program Name: "Good clinical practice- sterilization"

Date of activity: 19/02/2020

S.No	Name of the Faculty	Department	Signature
1	Dr. Babu Rao.	OPhtal.	Babu Rao
2	Dr. Bhavathi	SPM	Bhavathi
3	Dr. Bhavani	OBGY	Bhavani
4	Dr. Sindhu	Gen-Surg.	Sindhu
5	Dr. Indira Priyadarshini	Gen med	Indira
6	Dr. J. Lavitha Yasav.	Gen med	J. Lavitha
7	Dr. Nagababu.	Biochem	Nagababu
8	Dr. P. Korresh	Microbiology	P. Korresh
9	Dr. Sai Sravani	Gen med	Sai Sravani
10	Dr. Anandha Prasad	Gen med	Anandha Prasad
11	Dr. Dharani	Ortho	Dharani
12	Dr. Poornima Kumar	OBGY	Poornima Kumar
13	Dr. Balaji	Gen Med.	Balaji
14	Dr. Saellika	Gen Surg	Saellika

Program Co-Ordinator

PRINCIPAL
MNR Medical College & Hospital
Fasalwadi, Sangareddy

Chairperson
Internal Quality Assurance Cell (IQAC)
MNR Medical College & Hospital

HOD



MNR Medical College

Fasalwadi, Sangareddy, Hyderabad, Telangana-502 294.

Certificate of Participation

This is to certify that

_____ KURELLI PAVAN KALYAN _____

has participated in A Workshop on

“Good clinical practice- sterilization”

*on 19/02/2020 organised by ED Cell, conducted at MNR Medical College,
Fasalwadi, Sangareddy, Hyderabad, Telangana-502 294.*

Chairperson
Internal Quality Assurance Cell (IQAC)
MNR Medical College Hospital

PRINCIPAL

MNR Medical College & Hospital
FASALWADI, SANGAREDDY-502294



MNR Medical College

Fasalwadi, Sangareddy, Hyderabad, Telangana-502 294.

Certificate of Participation

This is to certify that

ROSHAN KUMAR M

has participated in A Workshop on

“Good clinical practice- sterilization”

*on 19/02/2020 organised by ED Cell, conducted at MNR Medical College,
Fasalwadi, Sangareddy, Hyderabad, Telangana-502 294.*

Chairperson
Internal Quality Assurance Cell (IQAC)
MNR Medical College
Hyderabad Hospital

PRINCIPAL

MNR Medical College & Hospital
FASALWADI, SANGAREDDY-502294



MNR Medical College

Fasalwadi, Sangareddy, Hyderabad, Telangana-502 294.

Certificate of Participation

This is to certify that

BANDYANA SALKUMAR

has participated in A Workshop on

“Good clinical practice- sterilization”

*on 19/02/2020 organised by ED Cell, conducted at MNR Medical College,
Fasalwadi, Sangareddy, Hyderabad, Telangana-502 294.*

Chairperson
Assurance Cell (IOAC)
Internal Quality
Improvement
Hospital
MNR Medical College

PRINCIPAL

MNR Principal
COLLEGE & HOSPITAL
FASALWADI, SANGAREDDY-502294



MNR Medical College

Fasalwadi, Sangareddy, Hyderabad, Telangana-502 294.

Certificate of Participation

This is to certify that

MUSKU NANDINI

has participated in A Workshop on

“Good clinical practice- sterilization”

*on 19/02/2020 organised by ED Cell, conducted at MNR Medical College,
Fasalwadi, Sangareddy, Hyderabad, Telangana-502 294.*

Chairperson
Assurance Cell (IQAC)
Internal Quality
Hyvener Hospital
MNR Medical College

PRINCIPAL
Principal
MNR Medical College & Hospital
FASALWADI, SANGAREDDY-502294



MNR Medical College

Fasalwadi, Sangareddy, Hyderabad, Telangana-502 294.

Certificate of Participation

This is to certify that

Dr. Babu Rao

has participated in A Workshop on

“Good clinical practice- sterilization”

*on 19/02/2020 organised by ED Cell, conducted at MNR Medical College,
Fasalwadi, Sangareddy, Hyderabad, Telangana-502 294.*

Chairperson
Assurance Cell (IOAC)
Internal Quality
MNR Medical College
Hyderabad Hospital

PRINCIPAL

MNR Principal
FASALWADI, SANGAREDDY-502294



MNR Medical College

Fasalwadi, Sangareddy, Hyderabad, Telangana-502 294.

Certificate of Participation

This is to certify that

Dr. Sindhu.

has participated in A Workshop on

“Good clinical practice- sterilization”

*on 19/02/2020 organised by ED Cell, conducted at MNR Medical College,
Fasalwadi, Sangareddy, Hyderabad, Telangana-502 294.*

Chairperson
Internal Quality Assurance Cell (IQAC)
MNR Medical College
Hyderabad Hospital

PRINCIPAL
MNR Medical College & Hospital
FASALWADI, SANGAREDDY-502294



MNR MEDICAL COLLEGE & HOSPITAL

MNR Nagar, Fasalwadi, Sangareddy - 502 294, Sangareddy Dist. Telangana. India

Ph: + 85000 56667, (08455) 230523, 230527, 230524 Fax No. (08455) - 230555, 230533

CIRCULAR

Date: 15-04-2020

All the staff members and students are invited for a seminar titled "Seminar on Biomedical waste handling" to be conducted by the ED Cell on 16th April 2020. The venue of the presentation is Demo Hall-II, Biochemistry, and Microbiology Laboratory. Please take this opportunity to enlighten yourself and enhance your career.

Principal

Copy to

- Medical Superintendent
- CEO
- Assistant Director
- Chief Academic Officer
- IQAC
- Concerned HODs
- Notice Boards

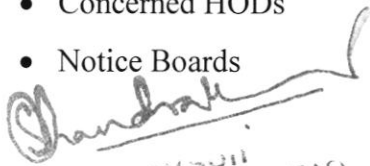
Chairperson
Internal Quality Assurance Cell (IQAC)
MNR Medical College & Hospital

PRINCIPAL
MNR Medical College & Hospital
Fasalwadi, Sanga Reddy



MNR MEDICAL COLLEGE & HOSPITAL

MNR Nagar, Fasalwadi, Sangareddy - 502 294, Sangareddy Dist. Telangana. India

Ph: + 85000 56667, (08455) 230523, 230527, 230524 Fax No. (08455) - 230555, 230533

Date: 17/04/2020

PROGRAM REPORT

Program Name: "Seminar on Biomedical waste handling"

Date of activity: 16/04/2020

Venue: Demo Hall-II, Biochemistry, and Microbiology Laboratory

Organized by: ED Cell

Resource person: Dr Suresh P, Consultant Microbiologist, Apollo Laboratories, Bangalore.

Number of participants: 91 Students & 12 Faculty

Objective of the program

The main objective of the seminar is to make everyone aware and protect our environment from pollution and contamination and repair and reduce the damage caused by pollution. Irresponsibly disposed of waste can lead to various diseases and can harm people.

Contents Delivered

- Separation (segregation)
- Identification (different color-coded bags)
- Handling (collection, measurement, storage, transport)
- Treatment (off-site and on-site)
- Waste reduction (by shredding)
- Disposal.

Outcome of the program

The seminar concentrated on the good clinical practice by learning basics of how to handle the biomedical waste and how the biomedical waste should be managed. The seminar also put view on how a good biomedical waste management will help to avoid the risk of contamination and also self risk from such hazardous waste material generated in hospital.

Chairperson
Internal Quality Assurance Cell (IQAC)
MNR Medical College & Hospital

PRINCIPAL
MNR Medical College & Hosp
Fasalwadi, Sanga Reddy



MNR MEDICAL COLLEGE & HOSPITAL

MNR Nagar, Fasalwadi, Sangareddy - 502 294, Sangareddy Dist. Telangana. India

Ph: + 85000 56667, (08455) 230523, 230527, 230524 Fax No. (08455) - 230555, 230533

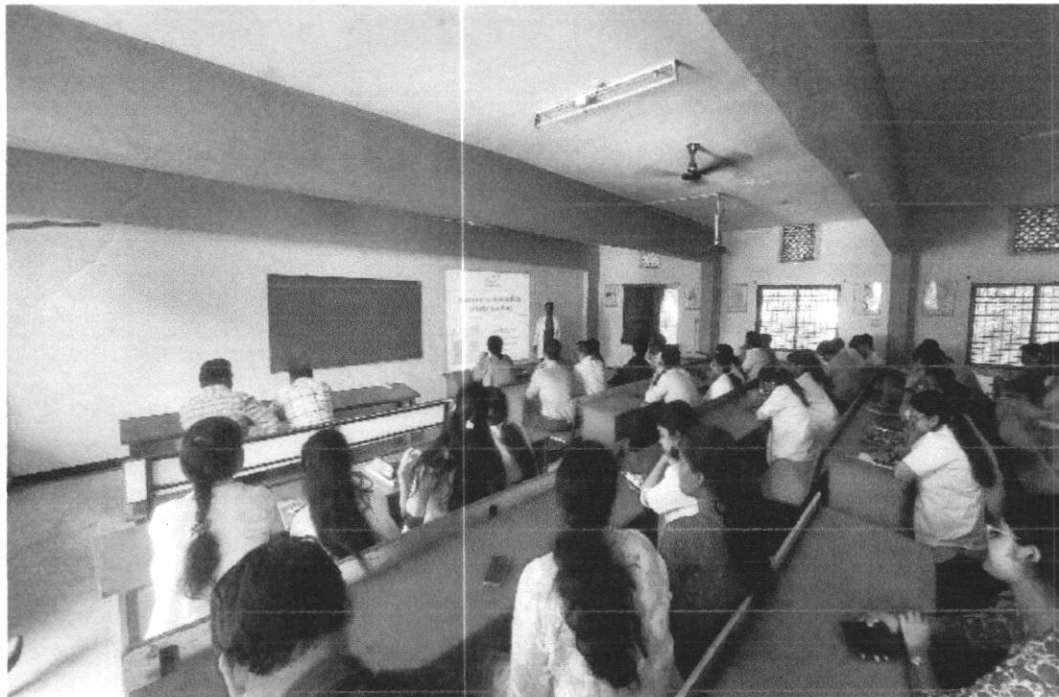

Chandrababu
Internal Convener,
MNR Medical College

My
PRINCIPAL

MNR MEDICAL COLLEGE & HOSPITAL,
FASALWADI, SANGAREDDY-502294

Chairperson
MEDICAL EDUCATION UNIT
MNR Medical College & Hospital



MNR MEDICAL COLLEGE & HOSPITAL

MNR Nagar, Fasalwadi, Sangareddy - 502 294, Sangareddy Dist. Telangana. India

Ph: + 85000 56667, (08455) 230523, 230527, 230524 Fax No. (08455) - 230555, 230533

Program Name: "Seminar on Biomedical waste handling"

Date of activity: 16/04/2020

S.No	Name of the participant	Course	Signature
1	PATLOLLA BHOOPAL REDDY	MBBS	P.B.Reddy
2	MEDI ANUP RAO	MBBS	Anup
3	NUKALA NIHITHA	MBBS	Nihitha
4	YASHASREE PASUPULETI	MBBS	yashasree
5	SOMA NITISH REDDY	MBBS	Nitish Reddy
6	ROSHAN KUMAR M	MBBS	Roshan
7	BANDYALA SAIKUMAR	MBBS	Saikumar
8	NIKHITA NADIMPALLI	MBBS	Nikhitha
9	MUSKU NANDINI	MBBS	Nandini
10	AKULA PALLAVI	MBBS	Pallavi
11	KONGALA RISHITHA	mbbs	Rishitha
12	GOLKONDA KARTHIK	MBBS	Karthik
13	BIRADAR SAIKUMAR	MBBS	Saikumar
14	NAIKOTI RAHUL	MBBS	Rahul
15	KOTHURU SUSHANTH	MBBS	Sushanth
16	SEVELLA MANOJ KUMAR	MBBS	Manoj Kumar
17	DANDYAR SHIVA PRASAD	MBBS	Shiva
18	BURRA JEEVANA	MBBS	Jeevana
19	MALELA BHANU PRASAD GOUD	MBBS	Bhanu Prasad
20	AKKENAPALLY RAJASHEKARACHARY	MBBS	Rajashekar
21	JANGITI MANEESHA	MBBS	Maneesha
22	BOLLOJU GURU PRASAD	MBBS	Prasad
23	P SRILEKHA	MBBS	SRILEKHA
24	MORAM STOTRA PRIYA	MBBS	Priya

PRINCIPAL
MNR Medical College & Hospital
Fasalwadi, Sangareddy
Chairperson
Internal Quality Assurance Cell (IQAC)
MNR Medical College & Hospital



MNR MEDICAL COLLEGE & HOSPITAL

MNR Nagar, Fasalwadi, Sangareddy - 502 294, Sangareddy Dist. Telangana. India

Ph: + 85000 56667, (08455) 230523, 230527, 230524 Fax No. (08455) - 230555, 230533

25	RACHANA RAPOLU	MBBS	RACHANA.R
26	M MANISHA GOUD	MBBS	M goud
27	OGGU SRIKANTH	MBBS	Srikanth
28	EDIGA SAI CHANDANA	MBBS	Sai
29	MARUGONDA SAKETH VARMA	MBBS	S/Varma
30	ANUMALLA MANASWINI	MBBS	Manu.
31	BANDI NAVEEN KUMAR	MBBS	N Kumar
32	SHAIK HASNAD BABA	MBBS	Shaik Baba
33	MAHEEN SULTANA	MBBS	M sult
34	BANOTH VASANTH KUMAR	MBBS	Vasanthkumar
35	B ANJALI NAIK	MBBS	B. Anjali Naik
36	MALAGARI MANEESHA	MBBS	Manu
37	CHINMAYEE DESAI	MBBS	Desai
38	GAJULA SRI HARSHA CHAKRAVARTHY	MBBS	G. Harsha
39	MALKA HARSHITHA	MBBS	harshitha
40	MENDI DEEKSHITHA	MBBS	Deekshitha
41	YATHAM SRI HARIKA	MBBS	Harika
42	J AISHWARYA	MBBS	J. Aishwarya
43	MUTHERAGALLA PRATHYUSHA	MBBS	Prathyusha
44	SEELAM LAXMI PRIYA	MBBS	Seelam
45	BANDILA V V S TANMAIYEE	MBBS	Tanmaiyye
46	GADDAM SRINIVAS	MBBS	Srinivas
47	SK AJEETH MUSHRAF	MBBS	Mushraf
48	GAJULA CHANDRA HASA	MBBS	Chandra
49	SALADI SAI VENKATA SOWMYA SARADA	MBBS	Sowmya
50	SHRUTI BOSE	MBBS	Bose
51	DODDIPALLI BHANU PRAKASH REDDY	MBBS	PB Prakash
52	SABHADU SUSHMITHA	MBBS	Sushmitha
53	PRIYANKA RAJ KUMAWAT	MBBS	Priyanka
54	MUGA RITHIKA	MBBS	Muga Rithika

PRINCIPAL
MNR Medical College & Hospital,
Fasalwadi, Sanga Reddy

Chairperson
Internal Quality Assurance Cell (IQAC)
MNR Medical College & Hospital



MNR MEDICAL COLLEGE & HOSPITAL

MNR Nagar, Fasalwadi, Sangareddy - 502 294, Sangareddy Dist. Telangana. India

Ph: + 85000 56667, (08455) 230523, 230527, 230524 Fax No. (08455) - 230555, 230533

55	R PRANITH KAMLAY	MBBS	Pranith
56	MARPALIKAR YOGESHWARI CHANDRAKANT	MBBS	Yogeeswari
57	RAJA RAJESWAR REDDY ATTLA	MBBS	Raja
58	NABAMITA CHAKRABORTY	MBBS	Nabamita
59	SHUBAM DILIP SHINDE	MBBS	Shubam Dilip
60	BODDAM CHANDRALEKHA	MBBS	Chandra
61	ROHIT JAJU	MBBS	Rohit
62	NABA KHANAM	MBBS	Naba
63	JAKAREGARI SOLOMON SUMAHITH SURATHAN	MBBS	Sumahith
64	AMBATI SAI KEERTHANA	MBBS	Keerthana
65	DAKSHA LONAVATH	MBBS	Daksha
66	ESLAVATH GANESH KUMAR	MBBS	Eslesh
67	PANDHIPATI RAMYAPRIYA	MBBS	Riya
68	GOLAMARI PRANAY PAUL REDDY	MBBS	Pranay
69	CHETANA MAHARANA	MBBS	Chethana
70	RANOO PRIYAMBADA BISWAL	MBBS	Priya
71	KUKUDALA KEERTHI	MBBS	Keerthy
72	HAJIRA NOOREIN	MBBS	Noorein
73	GRUSHA VARMA	MBBS	Grusha
74	DURGAPPAGARI KIRANGOUD	MBBS	Kirangoud
75	DANUGURI UMA	MBBS	Uma
76	APPADI DIVYA	MBBS	Divya
77	GIDDI RAM VARSHITH REDDY	MBBS	Ram
78	KOTHAPALLI SAICHANDANA	MBBS	Saichandana
79	POLE MOUNIKA	MBBS	Mounika
80	ADELLI SRIDHAR	MBBS	Sridhar
81	BHUKYA HARSHA	MBBS	Harsha
82	PERUMANDLA HANISHA	MBBS	Hanisha
83	GEENUKUNTA AMRUTH KUMAR	MBBS	Amruth
84	JOGINAPALLY GAYATHRI	MBBS	Gayathri
85	GUNTOJU SUDEEP	MBBS	Sudeep
86	NUTALAPATI MOHAN KRISHNA	MBBS	Mohan

PRINCIPAL
MNR Medical College & Hospital,
Fasalwadi, Sanga Reddy.

Internal Quality Assurance
MNR Medical College & Hospital



MNR MEDICAL COLLEGE & HOSPITAL

MNR Nagar, Fasalwadi, Sangareddy - 502 294, Sangareddy Dist. Telangana. India

Ph: + 85000 56667, (08455) 230523, 230527, 230524 Fax No. (08455) - 230555, 230533

87	PRANEESHA REDDY KANDI	MBBS	Praneesha Reddy
88	RAPAKA SHERLY	MBBS	R. Sherly
89	SHIVDUTT S KANDI	MBBS	Shivdutt
90	KADIYALA LIKHITHAA	MBBS	Likitha
91	YEDIVALLY PRASHANTH REDDY	MBBS	Prashanth

Program Co-Ordinator
HOD

Chandrababu
Chairperson
Internal Quality Assurance Cell (IQAC)
MNR Medical College & Hospital

FACULTY ATTENDANCE SHEET

Program Name: "Seminar on Biomedical waste handling"

Date of activity: 16/04/2020

S.No	Name of the Faculty	Department	Signature
1	Dr. Rudra Prasad	General Surgery	<i>Rudra</i>
2	Dr. Amarendra Potluri	General Surgery	<i>Amarendra</i>
3	Dr. Lingaraj Lature	General medicine	<i>Lature</i>
4	Dr. Babu Rao	Ophthalmology	<i>Babu Rao</i>

PRINCIPAL
MNR Medical College & Hospital
Fasalwadi, Sangareddy



MNR MEDICAL COLLEGE & HOSPITAL

MNR Nagar, Fasalwadi, Sangareddy - 502 294, Sangareddy Dist. Telangana. India

Ph: + 85000 56667, (08455) 230523, 230527, 230524 Fax No. (08455) - 230555, 230533

5	Dr. Bhavani	OBGY	Bhavani
6	Dr. Sunitha	Anatomy	Sunitha
7	Dr. Jaiich Yadav	Genl Surgery	Jaiich
8	Dr. Indira Priyadarshini	General medicine	Indira
9	Dr. A. Hari Priya	OBGY	Hari Priya
10	Dr. P. Suresh	microbiology	P. Suresh
11	Dr. Keerthi Sree Reddy	Gen medicine	Keerthi
12	Dr. Nagababu	Biochem	Nagababu

Program Co-Ordinator
HOD

Internal Quality Assurance Cell (IQAC)
MNR Medical College & Hospital

PRINCIPAL
MNR Medical College & Hospital
Fasalwadi, Sangareddy



MNR Medical College

Fasalwadi, Sangareddy, Hyderabad, Telangana-502 294.

CERTIFICATE OF PARTICIPATION

This is to certify that

_____ Pastella Bhoopa Reddy, _____
has participated in A Workshop on ✓

“Seminar on Biomedical waste handling”

on 16/04/2020organised by ED Cell, conducted at MNR Medical College,
Fasalwadi, Sangareddy, Hyderabad, Telangana-502 294.

S. Chandrababu Naidu

Internal Quality Assurance Cell (IQAC)
MNR Medical College & Hospital
Convener



Principal
MNR MEDICAL COLLEGE & HOSPITAL
FASALWADI, SANGAREDDY-502294

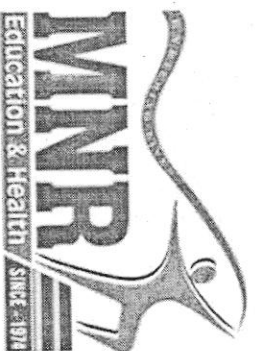

MNR Medical College

Fasalwadi, Sangareddy, Hyderabad, Telangana-502 294.

CERTIFICATE OF PARTICIPATION

This is to certify that

Nakala Nikhitha.

has participated in A Workshop on

“Seminar on Biomedical waste handling”

on 16/04/2020organised by ED Cell, conducted at MNR Medical College,
Fasalwadi, Sangareddy, Hyderabad, Telangana-502 294.

Internal Quality Assurance Cell (IQAC)
MNR Medical College & Hospital
Convener

Principal
MNR MEDICAL COLLEGE & HOSPITAL
FASALWADI, SANGAREDDY-502294.



MNR Medical College

Fasalwadi, Sangareddy, Hyderabad, Telangana-502 294.

CERTIFICATE OF PARTICIPATION

This is to certify that

Buxta Tevanna.

has participated in A Workshop on

“Seminar on Biomedical waste handling”

on 16/04/2020organised by ED Cell, conducted at MNR Medical College,
Fasalwadi, Sangareddy, Hyderabad, Telangana-502 294.



Internal Quality Assurance Cell (IQAC)
MNR Medical College & Hospital
Convener



Principal
MNR MEDICAL COLLEGE & HOSPITAL
FASALWADI, SANGAREDDY-502294

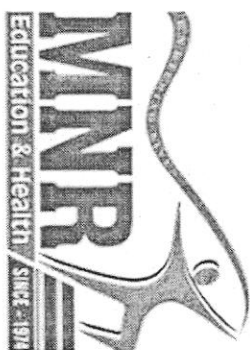

MNR Medical College

Fasalwadi, Sangareddy, Hyderabad, Telangana-502 294.

CERTIFICATE OF PARTICIPATION

This is to certify that

Dr. Alauk Yadav,

has participated in A Workshop on

“Seminar on Biomedical waste handling”

on 16/04/2020organised by ED Cell, conducted at MNR Medical College,
Fasalwadi, Sangareddy, Hyderabad, Telangana-502 294.

A handwritten signature in black ink, appearing to read 'Sandhya'.

Internal Quality Assurance Cell (IQAC)
MNR Medical College & Hospital
Convener

A handwritten signature in black ink, appearing to read 'Principal'.

Principal
MNR MEDICAL COLLEGE & HOSPITAL
FASALWADI, SANGAREDDY-502294

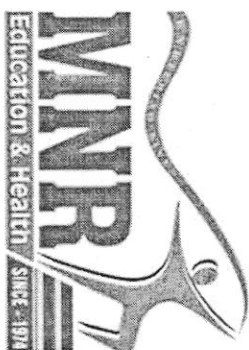

MNR Medical College

Fasalwadi, Sangareddy, Hyderabad, Telangana-502 294.

CERTIFICATE OF PARTICIPATION

This is to certify that

Dr. Ruba Pawar.

has participated in A Workshop on

“Seminar on Biomedical waste handling”

on 16/04/2020organised by ED Cell, conducted at MNR Medical College,
Fasalwadi, Sangareddy, Hyderabad, Telangana-502 294.

A handwritten signature in black ink, appearing to read 'Sharda'.

Internal Quality Assurance Cell (IQAC)
MNR Medical College & Hospital
Convener

A handwritten signature in black ink, appearing to read 'Principal'.

Principal
MNR MEDICAL COLLEGE & HOSPITAL
FASALWADI, SANGAREDDY-502294

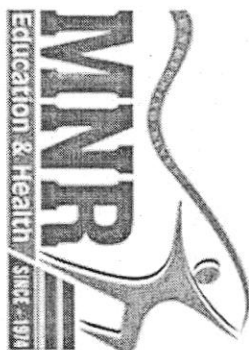

MNR Medical College

Fasalwadi, Sangareddy, Hyderabad, Telangana-502 294.

CERTIFICATE OF PARTICIPATION

This is to certify that

Dr. Hasi Priya.

has participated in A Workshop on

“Seminar on Biomedical waste handling”

on 16/04/2020organised by ED Cell, conducted at MNR Medical College,
Fasalwadi, Sangareddy, Hyderabad, Telangana-502 294.



Internal Quality Assurance Cell (IQA)
MNR Medical College & Hospital
Convener



Principal
MNR MEDICAL COLLEGE & HOSPITAL
FASALWADI, SANGAREDDY-502294.



MNR MEDICAL COLLEGE & HOSPITAL

MNR Nagar, Fasalwadi, Sangareddy - 502 294, Sangareddy Dist. Telangana. India

Ph: + 85000 56667, (08455) 230523, 230527, 230524 Fax No. (08455) - 230555, 230533

CIRCULAR

Date: 14-12-2020

All the staff members and students are invited for a seminar titled "Research Methodology – Basics of Biostatistics" to be conducted by the R&D Cell on 21st December 2020. The venue of the presentation is Biochemistry Demo Hall 2. Please take this opportunity to enlighten yourself and enhance your career.

Principal

Copy to

- Medical Superintendent
- CEO
- Assistant Director
- Chief Academic Officer
- IQAC
- Concerned HODs
- Notice Boards

PRINCIPAL
MNR Medical College & Hospital
Fasalwadi, Sanga Reddy.

Chairperson
Internal Quality Assurance Cell (IQAC)
MNR Medical College & Hospital



MNR MEDICAL COLLEGE & HOSPITAL

MNR Nagar, Fasalwadi, Sangareddy - 502 294, Sangareddy Dist. Telangana. India

Ph: + 85000 56667, (08455) 230523, 230527, 230524 Fax No. (08455) - 230555, 230533

Date: 24/12/2020

PROGRAM REPORT

Program Name: "Research Methodology – Basics of Biostatistics"

Date of activity: 21/12/2020

Venue: Biochemistry Demo Hall 2

Organized by: R&D Cell

Resource person: Mr Simhadri M Tutor and Research Data scientist, Community Medicine
Department, MNR Medical College & Hospital, Sangareddy

Number of participants: 98 Students & 17 Faculty

Objective of the program

Seminar was organized for the Students and Academicians to The objective of Biostatistics is to advance statistical science and its application to problems of human health and disease, with the ultimate goal of advancing the public's health.

Contents Delivered

- Case Studies.
- Correlational Studies.
- Longitudinal Studies.
- Experimental Studies.
- Clinical Trial Studies.

Outcome of the program

The participants of the Seminar will be able to understand the discipline of biostatistics which provides tools and techniques for collecting data and then summarizing, analyzing, and interpreting it. If the samples one takes are representative of the population of interest, they will provide good estimates regarding the population overall.

PRINCIPAL
MNR Medical College & Hospital
Fasalwadi, Sanga Reddy.



Chairperson
Internal Quality Assurance Cell (IQAC)
MNR Medical College & Hospital



MNR MEDICAL COLLEGE & HOSPITAL

MNR Nagar, Fasalwadi, Sangareddy - 502 294, Sangareddy Dist. Telangana. India

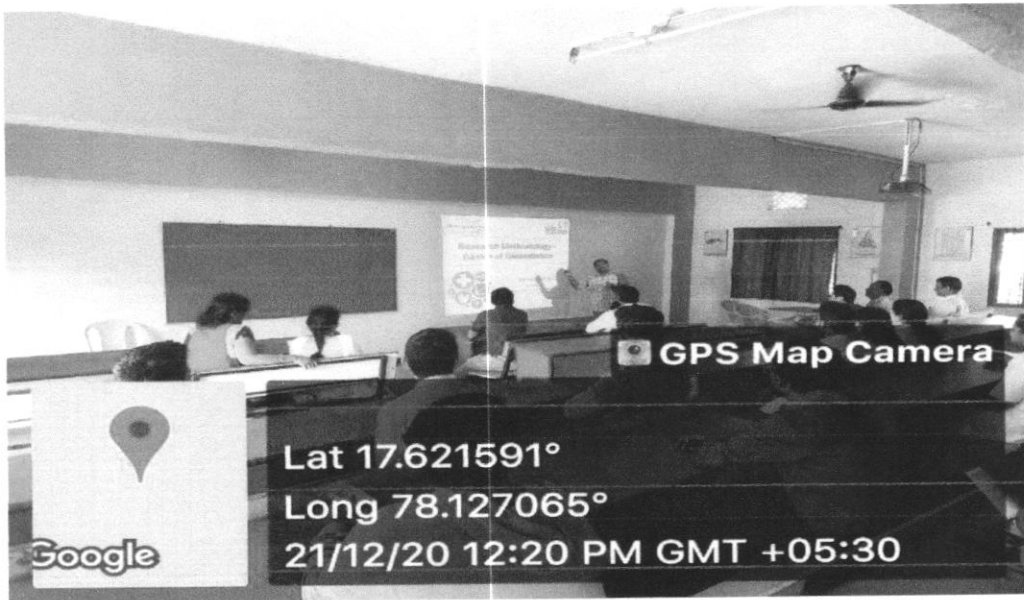
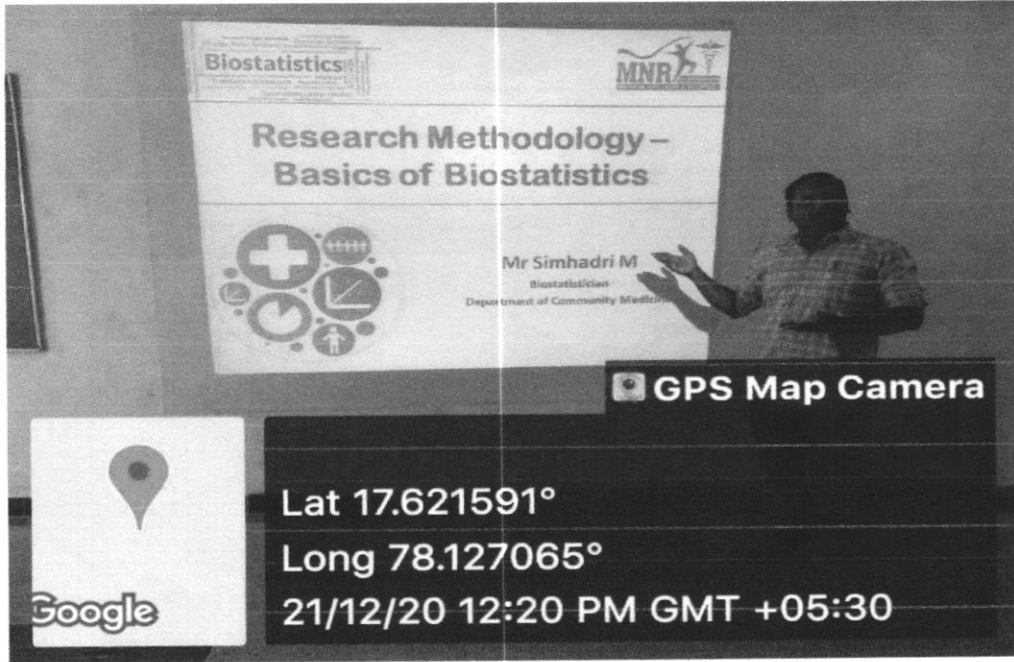
Ph: + 85000 56667, (08455) 230523, 230527, 230524 Fax No. (08455) - 230555, 230533



Chandrasekhar

Chairperson
Internal Quality Assurance Cell (IQAC)
MNR Medical College & Hospital

Shy

Chandrasekhar

Chairperson
MEDICAL EDUCATION UNIT
MNR Medical College & Hospital

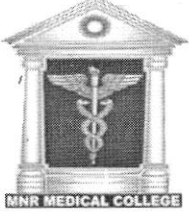

MNR MEDICAL COLLEGE & HOSPITAL

MNR Nagar, Fasalwadi, Sangareddy - 502 294, Sangareddy Dist. Telangana. India

Ph: + 85000 56667, (08455) 230523, 230527, 230524 Fax No. (08455) - 230555, 230533

STUDENT ATTENDANCE SHEET

Program Name: "Research Methodology – Basics of Biostatistics"

Date of activity: 21/12/2020

S.No	Name of the participant	Course	Signature
1	SEELAM LAXMI PRIYA	MBBS	Laxmi
2	BANDILA V V S TANMAIYEE	MBBS	Tanmaiye
3	GADDAM SRINIVAS	MBBS	Srinivas
4	SK AJEETH MUSHRAF	MBBS	Ajeeth
5	RAGAM SHALINI YADAV	MBBS	Shalini
6	MANISHA CHALLURI	MBBS	Manisha
7	MALLE SIMEON	MBBS	Simeon
8	TADIBOYINA KAVYA	MBBS	Kavya
9	AVVARU CHANDANA	MBBS	Chandana
10	LAUDIA TEJASVEE	MBBS	Tejasvee
11	R LAXMAN	MBBS	Laxman
12	KALIDINDI SONY SANTOSH VARMA	MBBS	Santosh
13	REMALLA APARAJITHA	MBBS	Aparajitha
14	KURRE SPANDANAREDDY	MBBS	Spandana
15	VEJELLA SWETHA DEVI	MBBS	Swetha
16	SRILEKHYA BANDARUPALLI	MBBS	Srilekhy
17	MUTTAVARAPU RAJYA LAKSHMI	MBBS	Rajya Lakshmi
18	TAMMEWAR GURURAJ SANTOSHRAO	MBBS	Gururaj
19	TIRUMALASETTI S L BHAVANA	MBBS	Bhavana
20	SRAVANTHI ALLADA	MBBS	Sravanthi
21	T N MADHURI	MBBS	Madhuri

PRINCIPAL
MNR Medical College & Hospital
Fasalwadi, Sanga Reddy.

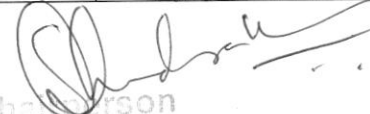
Chairperson
Internal Quality Assurance Cell (IQAC)
MNR Medical College & Hospital



MNR MEDICAL COLLEGE & HOSPITAL

MNR Nagar, Fasalwadi, Sangareddy - 502 294, Sangareddy Dist. Telangana. India

Ph: + 85000 56667, (08455) 230523, 230527, 230524 Fax No. (08455) - 230555, 230533

22	JILLELA VENKATESWARA REDDY	MBBS	Venkatesh
23	PUPPALA SANJANA	MBBS	Sanjana
24	VINEESHA YADAV A	MBBS	Vinestha
25	D PRIYA	MBBS	Priya
26	SRISHTI PANDEY	MBBS	Srishti
27	NARRA DIVYASREE	MBBS	Divya
28	POPPADI MOUNICA	MBBS	Mounica
29	PAMBALLA ANUSHA	MBBS	Anusha
30	PALAGIRI SAI KEERTHANA REDDY	MBBS	Keerthana
31	VUSKEMALLA ABHIRAM	MBBS	Abhiram
32	DASARI SWATHI	MBBS	Swathi
33	KANDHUKURI BHUMIKA	MBBS	Bhumika
34	KANUKUNTA SAI PRIYA	MBBS	Priya
35	HONSHETTE SINNI	MBBS	Sinni
36	REYA ROY	MBBS	Reya
37	CHINTALA VANAJA RANI	MBBS	Vanaja
38	AKULA SURAJ	MBBS	SURAJ
39	MENGJI NITISHA	MBBS	Nitisha
40	SHAIK JUVERIYA MAHI	MBBS	Juveriya
41	THOOTIPALLI MANICHANDANA	MBBS	Manichandana
42	YEDLAPALLEY SRIVALLI	MBBS	Srivalli
43	MALOTHU SANDHYA	MBBS	Sandhya
44	DOPPALAPUDI NIHARIKA	MBBS	Niharika
45	NELLUTLA MILIND	MBBS	Milind
46	GANJI VARSHA	MBBS	Varsha
47	MYAKALA RAMESH	MBBS	Ramesh
48	KAVALI SUPRIYA	MBBS	Supriya

PRINCIPAL
MNR Medical College & Hospital
Fasalwadi, Sanga Reddy.

Chairperson
Internal Quality Assurance Cell (IQAC)
MNR Medical College & Hospital



MNR MEDICAL COLLEGE & HOSPITAL

MNR Nagar, Fasalwadi, Sangareddy - 502 294, Sangareddy Dist. Telangana. India

Ph: + 85000 56667, (08455) 230523, 230527, 230524 Fax No. (08455) - 230555, 230533

49	NOOREEN FATIMA	MBBS	Fathima
50	MAGULURI SUNIDHI	MBBS	Sunidhi
51	BOYAPALLY KIRANMAI	MBBS	Kiranmai
52	TANAKAM YASHWANTHI	MBBS	Yashwanthi
53	K.RAMYA	MBBS	K.Ramya
54	DHANCETTI KAVERI	MBBS	Kaveri
55	CHOUTIPELLY AKHILESH	MBBS	Akhilesh
56	DASARI SUDESHNA	MBBS	SUDESHNA
57	SALADI SRI RAJESWARI	MBBS	Sri Rajeswari
58	ADITI ASTHANA	MBBS	ADITI
59	KONKATHI SHRUTHI	MBBS	Shruthi
60	DEVANSH PARLAWAR	MBBS	Devansh
61	DOWPATI YAMINI	MBBS	Yamini
62	SAI SRI LAKSHMI SUGANDHI VADDI	MBBS	Sugandhi
63	KODATHALA DHARANESWAR REDDY	MBBS	Dharaneswar
64	JANAMANCHI ADITHYA	MBBS	Adithya
65	MANIKONDA GOPI KRISHNA SAI	MBBS	Gopi
66	GEDELA UMAMAHESHWAR RAO	MBBS	Umaswari
67	K CHANDRAPRADHYUMNA REDDY	MBBS	Pradhyuma
68	VEMUGANTI PRANEETH KUMAR	MBBS	Praneeth
69	NISHITA PATWARDHAN	MBBS	Nishita
70	SARMADA YELLAPRAGADA	MBBS	Sarmada
71	UGGELLI NAVEEN REDDY	MBBS	Naveen
72	SAMALA TEJA TAPASWI	MBBS	Teja
73	KOTHAGATTU VYSHNAVI	MBBS	Vyshnavi
74	DASYAM RISHIKA	MBBS	Rishi
75	POLA SANTOSH KUMAR	MBBS	Santosh
76	JANGA MANASVINI REDDY	MBBS	Manasvini
77	A PRAJWALIKA	MBBS	Prajwalika
78	SAMALA SATWIKK CHAITANYA	MBBS	Satwik

PRINCIPAL
MNR Medical College & Hospital
Fasalwadi, Sanga Reddy.

Chairperson
Internal Quality Assurance Cell (IQAC)
MNR Medical College & Hospital



MNR MEDICAL COLLEGE & HOSPITAL

MNR Nagar, Fasalwadi, Sangareddy - 502 294, Sangareddy Dist. Telangana. India

Ph: + 85000 56667, (08455) 230523, 230527, 230524 Fax No. (08455) - 230555, 230533

79	BODALA VENKATA SUJITH	MBBS	Venkata
80	BHUBALE SIDDHESH DATTA	MBBS	Siddesh.
81	MEGHANA POTHULA	MBBS	Meghana
82	NUTANA T	MBBS	NUTANA.
83	VUPPALAPATI VASHU KRISHNA	MBBS	Krishna
84	BETHU LOHITHA LAKSHMI	MBBS	Lakshmi
85	P S S KAUSTUBH JAIN	MBBS	Kaustubh
86	M A GHANI	MBBS	Ghani
87	L VENKAT VAISHNAVI	MBBS	Vaishnavi
88	SOWMYA AMRUTHAM	MBBS	Amrutham
89	MANDOLLA ALEKHYA	MBBS	Alekhye
90	ANUGU GREESHMITHA	MBBS	Greeshma
91	REDDYPOGU ANJALI	MBBS	Anjali
92	KUTADI USHA SREE	MBBS	Usha
93	UPPU VARUN KUMAR	MBBS	Varun
94	KATTAKINDI SATISH GOUD	MBBS	Satish
95	BAIRU DIVYA	MBBS	Divya
96	AENAGANDULA AKSHAYA	MBBS	Akshaya
97	MULLE NAVEEN KUMAR	MBBS	Naveen
98	JADLOD LALITHA	MBBS	Jadlod

Program Co-Ordinator

PRINCIPAL
MNR Medical College & Hospital
Fasalwadi, Sangareddy.

Chairperson
Internal Quality Assurance Cell (IQAC)
MNR Medical College & Hospital
HOD



MNR MEDICAL COLLEGE & HOSPITAL

MNR Nagar, Fasalwadi, Sangareddy - 502 294, Sangareddy Dist. Telangana. India

Ph: + 85000 56667, (08455) 230523, 230527, 230524 Fax No. (08455) - 230555, 230533

FACULTY ATTENDANCE SHEET

Program Name: "Research Methodology - Basics of Biostatistics"

Date of activity: 21/12/2020

S.No	Name of the Faculty	Department	Signature
1	Dr. Karthik	Gen Surgery	
2	Dr. Nagababu	Biochem	
3	Dr. N. Deepika	OPHTH	
4	Dr. Rudra Prasad	Gen Surg	
5	Dr. Babu Rao	OPHTH	
6	Dr. Manisha	General Surgeon	
7	Dr. Sumithra	Anatomy	
8	Dr. Ilaiyan Yadau	General Surgery	
9	Dr. Prasanna Devi	OBG	
10	Dr. Anurag Yadav	Biochem	
11	Dr. Bhavani	OBGY	
12	Dr. Sindhu	Gen. Surg.	
13	Dr. Anorekha Prasad	General Surgery	
14	Dr. Priyadarshini	Gen Med	
15	Dr. P. Suresh	microbiology	
16	Dr. Chidambaram S		
17	Dr. Dharaani	Ortho	

Program Co-Ordinator

PRINCIPAL
MNR Medical College & Hospital
Fasalwadi, Sangareddy

Chairperson
Internal Quality Assurance Cell (IQAC)
MNR Medical College & Hospital

HOD



MNR Medical College

Fasalwadi, Sangareddy, Hyderabad, Telangana-502 294.

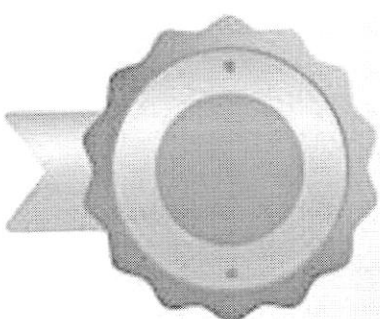

Certificate of Participation

THIS IS TO CERTIFY THAT

DR. AMERENDRA PRASAD

HAS PARTICIPATED IN A WORKSHOP ON

"Biostatistics"

**ON 17/07/2018 ORGANISED BY R&D CELL, CONDUCTED AT MNR MEDICAL COLLEGE,
FASALWADI, SANGAREDDY, HYDERABAD, TELANGANA-502 294.**

Convener

Principal
PRINCIPAL

MNR MEDICAL COLLEGE & HOSPITAL
FASALWADI, SANGAREDDY-502294

Chairpersons
Internal Quality Assurance Cell (IQAC)
MNR Medical College & Hospital



MNR Medical College

Fasalwadi, Sangareddy, Hyderabad, Telangana-502 294.

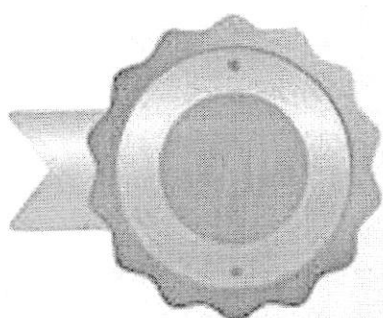

Certificate of Participation

THIS IS TO CERTIFY THAT

SELAM LAXMI PRIYA

HAS PARTICIPATED IN A WORKSHOP ON

"Biostatistics"

ON **17/07/2018** ORGANISED BY R&D CELL, CONDUCTED AT MNR Medical College,
Fasalwadi, Sangareddy, Hyderabad, TELANGANA-502 294.

Convener

Principal
PRINCIPAL

MNR MEDICAL COLLEGE & HOSPITAL
FASALWADI, SANGAREDDY-502294

Chairperson
Internal Quality Assurance Cell (IQAC)
MNR Medical College & Hospital



MNR Medical College

Fasalwadi, Sangareddy, Hyderabad, Telangana-502 294.

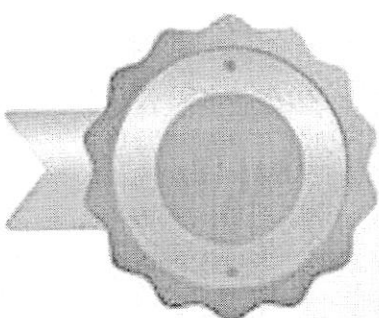

Certificate of Participation

THIS IS TO CERTIFY THAT

GADDAM SRINIVAS

HAS PARTICIPATED IN A WORKSHOP ON

"Biostatistics"

ON **17/07/2018** ORGANISED BY R&D CELL, CONDUCTED AT MNR MEDICAL COLLEGE,
FASALWADI, SANGAREDDY, HYDERABAD, TELANGANA-502 294.

Convener

Principal

MNR MEDICAL COLLEGE & HOSPITAL
FASALWADI, SANGAREDDY-502294

Chairperson
Internal Quality Assurance Cell (IQAC)
MNR Medical College & Hospital



MNR Medical College

Fasalwadi, Sangareddy, Hyderabad, Telangana-502 294.

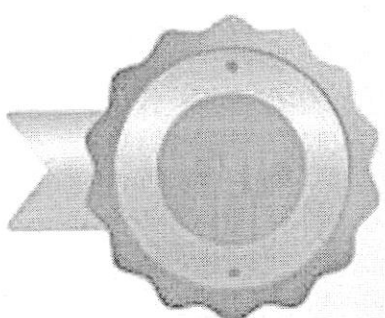

Certificate of Participation

THIS IS TO CERTIFY THAT

SK AITEETH MUSHRAE

HAS PARTICIPATED IN A WORKSHOP ON

"Biostatistics"

ON **17/07/2018** ORGANISED BY R&D CELL, CONDUCTED AT MNR Medical College,
Fasalwadi, SANGAREDDY, HYDERABAD, TELANGANA-502 294.

Chairperson
Convener

Principal

Chairperson
Internal Quality Assurance Cell (IQAC)
MNR Medical College & Hospital

Principal
MNR MEDICAL COLLEGE & HOSPITAL
FASALWADI, SANGAREDDY-502294



MNR Medical College

Fasalwadi, Sangareddy, Hyderabad, Telangana-502 294.

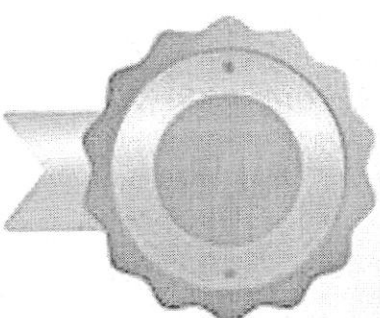

Certificate of Participation

THIS IS TO CERTIFY THAT

Dr. N. Deepika

HAS PARTICIPATED IN A WORKSHOP ON
"Biostatistics"

ON **17/07/2018** ORGANISED BY R&D CELL, CONDUCTED AT MNR Medical College,
Fasalwadi, Sangareddy, Hyderabad, Telangana-502 294.

Convener

Principal

MNR MEDICAL COLLEGE & HOSPITAL
FASALWADI, SANGAREDDY-502294

Chairperson
Internal Quality Assurance Cell (IQAC)
MNR Medical College & Hospital



MNR Medical College

Fasalwadi, Sangareddy, Hyderabad, Telangana-502 294.

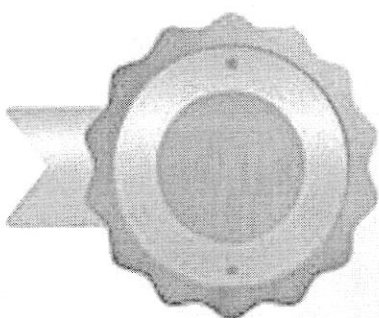

Certificate of Participation

THIS IS TO CERTIFY THAT

DR. ANURAG YADAV

HAS PARTICIPATED IN A WORKSHOP ON

"Biostatistics"

ON **17/07/2018** ORGANISED BY R&D CELL, CONDUCTED AT MNR MEDICAL COLLEGE,
FASALWADI, SANGAREDDY, HYDERABAD, TELANGANA-502 294.

Convener

Principal

PRINCIPAL

MNR MEDICAL COLLEGE & HOSPITAL
FASALWADI, SANGAREDDY-502294

Chairpersons
Internal Quality Assurance Cell (IQAC)
MNR Medical College & Hospital